

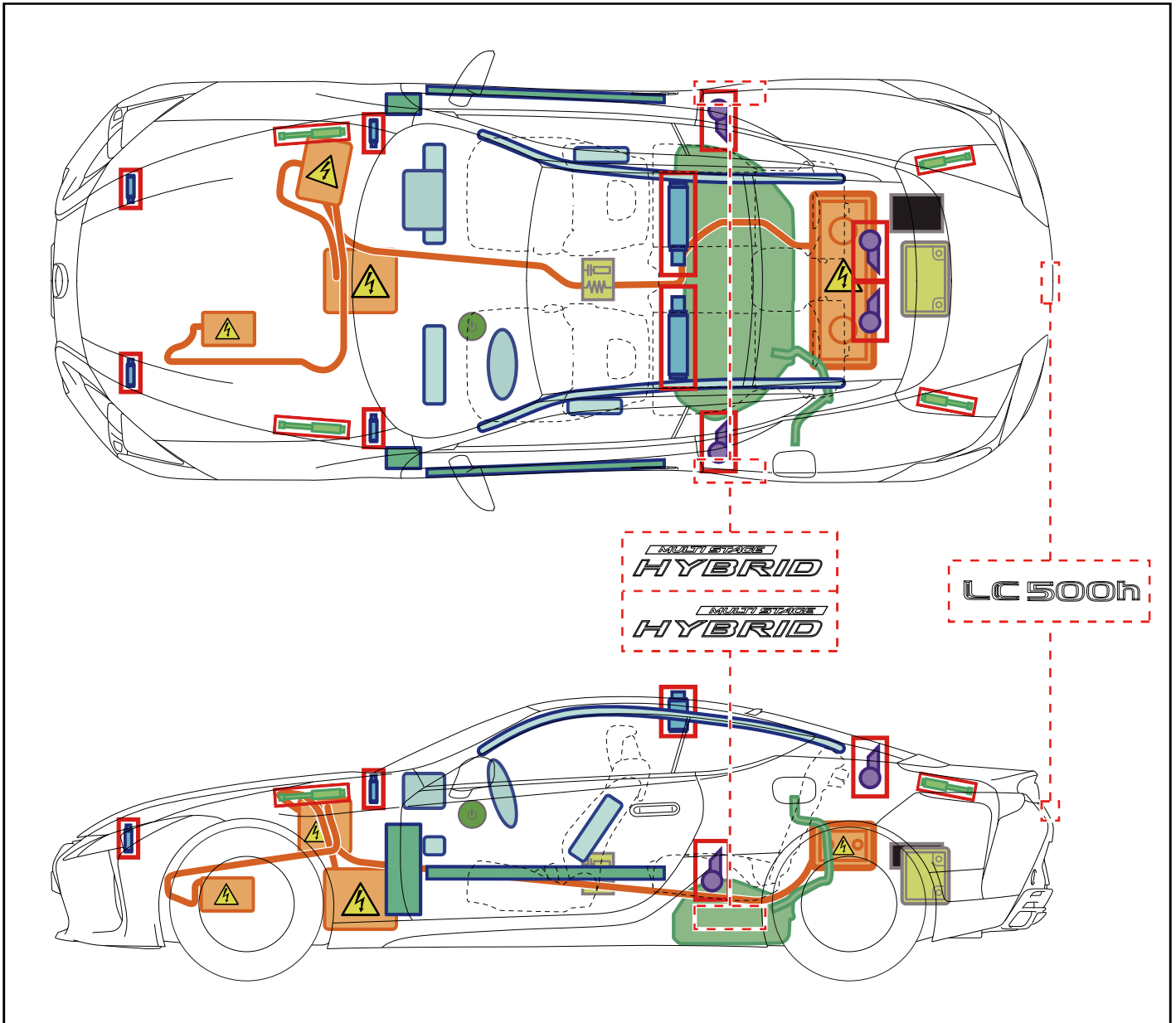

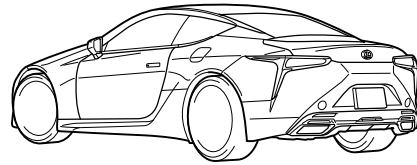

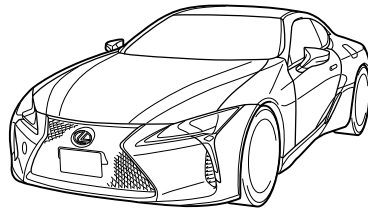







LC500h

Emergency Response Quick Guide

MY: 2018 -



	IG/POWER SW		Fuse Box		12V Battery
	Airbag (incl. Inflator)		Inflator		High Voltage Battery
	High Voltage Components		Fuel Tank		Gas-filled Damper
	Seat Belt Pretensioner (Gas Generator)		Structural Reinforcements		Airbag Computer
—	—	—	—	—	—

Disable Vehicle

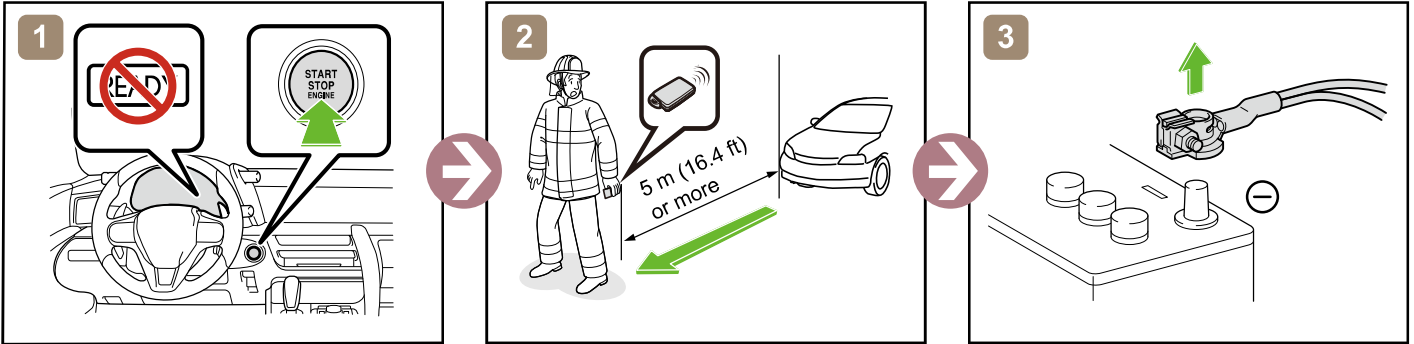

or

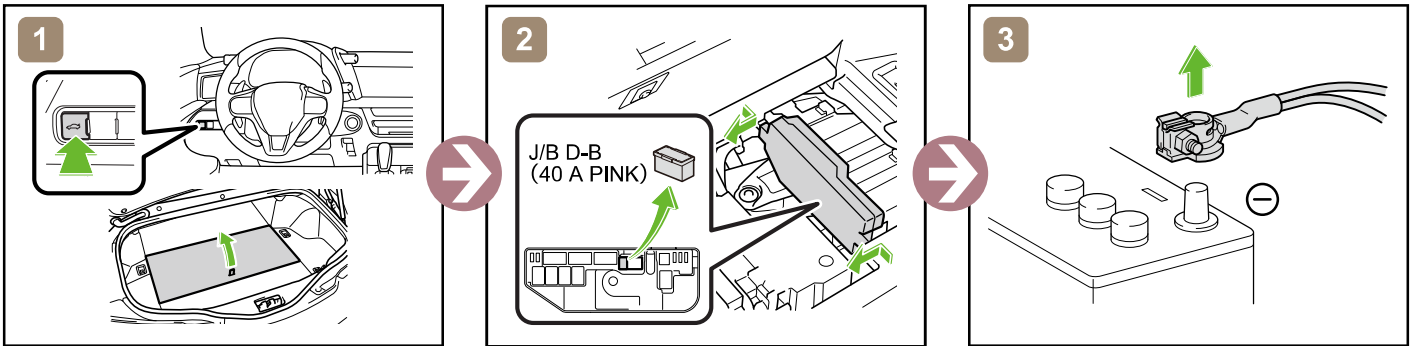

Access to 12V Battery

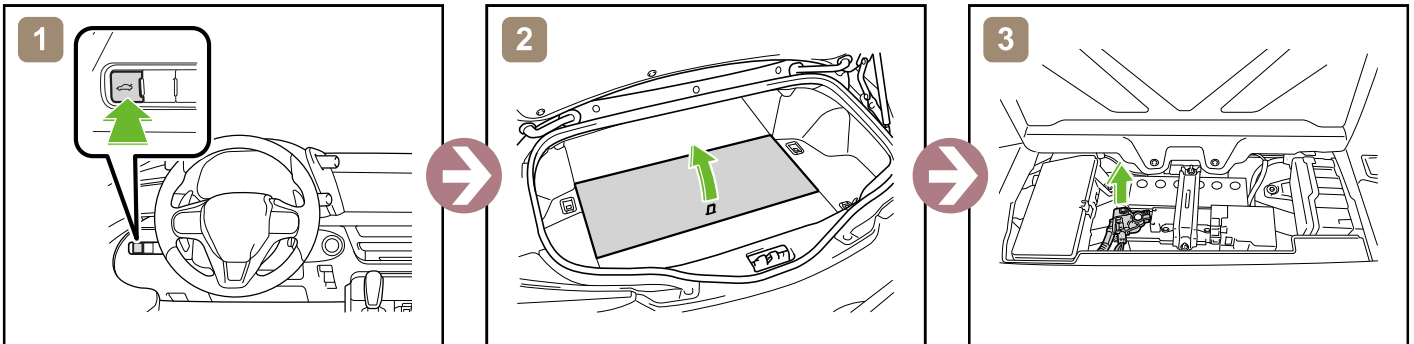

Towing Information

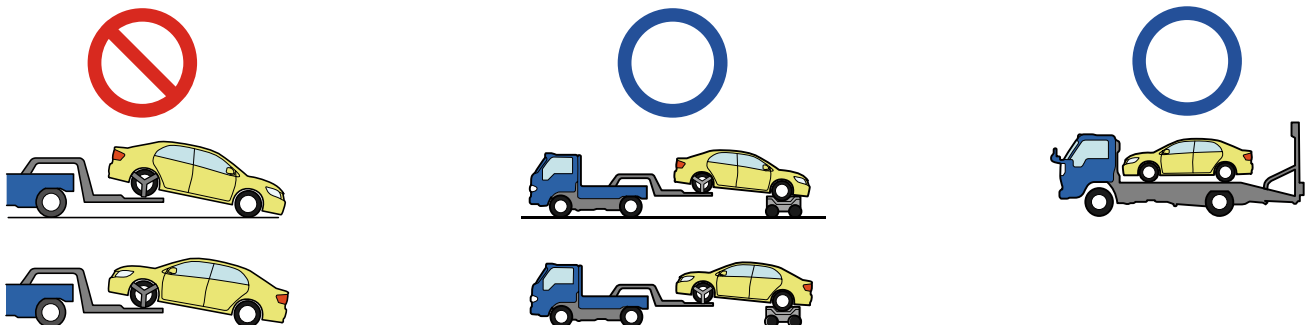

More details, please refer to "Emergency Response Guide".
<http://www.technifo.toyota.com>