



INFINITI®

2013 M35h HYBRID

First Responder's Guide



Foreword

This manual describes first response operations and warnings and cautions for this vehicle.

This vehicle is equipped with a high voltage Lithium-ion (Li-on) battery pack. **Failure to follow recommended practices during emergency responses will cause death or serious personal injury.**

Please read this manual in advance in order to understand the features of this vehicle and to help you deal with incidents involving this vehicle. Follow the procedures in order to help assure a successful first response operation.

INFINITI EMERGENCY CONTACT INFORMATION

- 1-800-662-6200 (US) or 1-800-361-4792 (Canada)
- Hours of operation are 8am-5pm (Monday-Friday) Eastern, Central and Pacific time zones

IMPORTANT INFORMATION ABOUT THIS MANUAL

You may see various symbols in this manual. They have the following meanings:



▲ DANGER

This symbol is used to inform you of an operation which will result in death or serious personal injury if instructions are not followed.

Example: Touching high voltage components without using the appropriate protective equipment will result in electrocution.

▲ WARNING

This symbol is used to inform you of an operation which may cause death or serious personal injury if instructions are not followed.

▲ CAUTION

This symbol is used to inform you of an operation which may cause personal injury or component damage if instructions are not followed.

Please note that there may be differences between this manual and the vehicle specification due to specification changes. In such a case, follow this manual.

Table of Contents

FOREWORD	2
INFINITI EMERGENCY CONTACT INFORMATION	2
IMPORTANT INFORMATION ABOUT THIS MANUAL	2
1. ABOUT THE INFINITI M35H HYBRID	4
1-1 M35H HYBRID IDENTIFICATION	5
1-1.1. EXTERIOR AND ENGINE COMPARTMENT	5
1-1.2. INTERIOR	6
1-2 VEHICLE IDENTIFICATION NUMBER (VIN) LAYOUT	7
1-3 WARNING AND INDICATOR LAMP INFORMATION	8
2. BASIC HIGH VOLTAGE SYSTEM AND 12V SYSTEM INFORMATION	10
2-1 BATTERY INFORMATION	10
2-1.1. LOW VOLTAGE BATTERY	10
2-1.2. LI-ION BATTERY	10
2-2 HIGH VOLTAGE-RELATED AND 12V-RELATED COMPONENT LOCATIONS AND DESCRIPTIONS	11
2-3 LI-ION BATTERY PACK SPECIFICATIONS	12
2-4 HIGH VOLTAGE SAFETY MEASURES	13
2-4.1. WARNING LABEL	13
2-5 HIGH VOLTAGE SAFETY SYSTEM	14
2-6 HIGH VOLTAGE CIRCUIT SHUT-OFF SYSTEM	15
2-7 PREVENTING ELECTRICAL SHOCK	15
2-8 EMERGENCY MEDICAL EQUIPMENT	15
3. EMERGENCY RESPONSE STEPS	16
3-1 PREPARATION ITEMS	17
3-1.1. PPE (PERSONAL PROTECTIVE EQUIPMENT) PROTECTIVE WEAR CONTROL	17
3-1.2. DAILY INSPECTION	17
3-1.3. INSULATED TOOLS	18
3-2 VEHICLE IMMOBILIZATION AND STABILIZATION	18
3-3 HOW TO HANDLE A DAMAGED VEHICLE AT AN ACCIDENT SCENE	18
3-3.1. HIGH VOLTAGE SYSTEM SHUT-DOWN PROCEDURE	19
3-3.2. WATER SUBMERSION	28
3-3.3. VEHICLE FIRE	28
3-3.4. CUTTING THE VEHICLE BODY	29
3-3.5. LI-ION BATTERY DAMAGE AND FLUID LEAKS	34
3-3.6. ACCESSING THE OCCUPANTS	35
4. EMERGENCY QUICK REFERENCE GUIDE	36

1. About the INFINITI M35h HYBRID

This hybrid electric vehicle (HEV) uses two types of batteries. One is a 12V battery that is the same as the battery in vehicles powered by internal combustion engines. The 12V battery is located behind the rear seat back with battery cable access through the trunk area. The other is the Lithium-ion (Li-ion) battery (high voltage) for the traction motor which propels the vehicle. The Li-ion battery is located behind the rear seat back with service plug access through the trunk area.

The high voltage Li-ion battery is recharged with an on-board DC/DC converter and generator powered by the engine. Additionally, the vehicle system can recharge the Li-ion battery by converting driving force into electricity while the vehicle is decelerating or being driven downhill. This is called regenerative charging.

1-1 M35h HYBRID IDENTIFICATION

1-1.1 Exterior and Engine Compartment

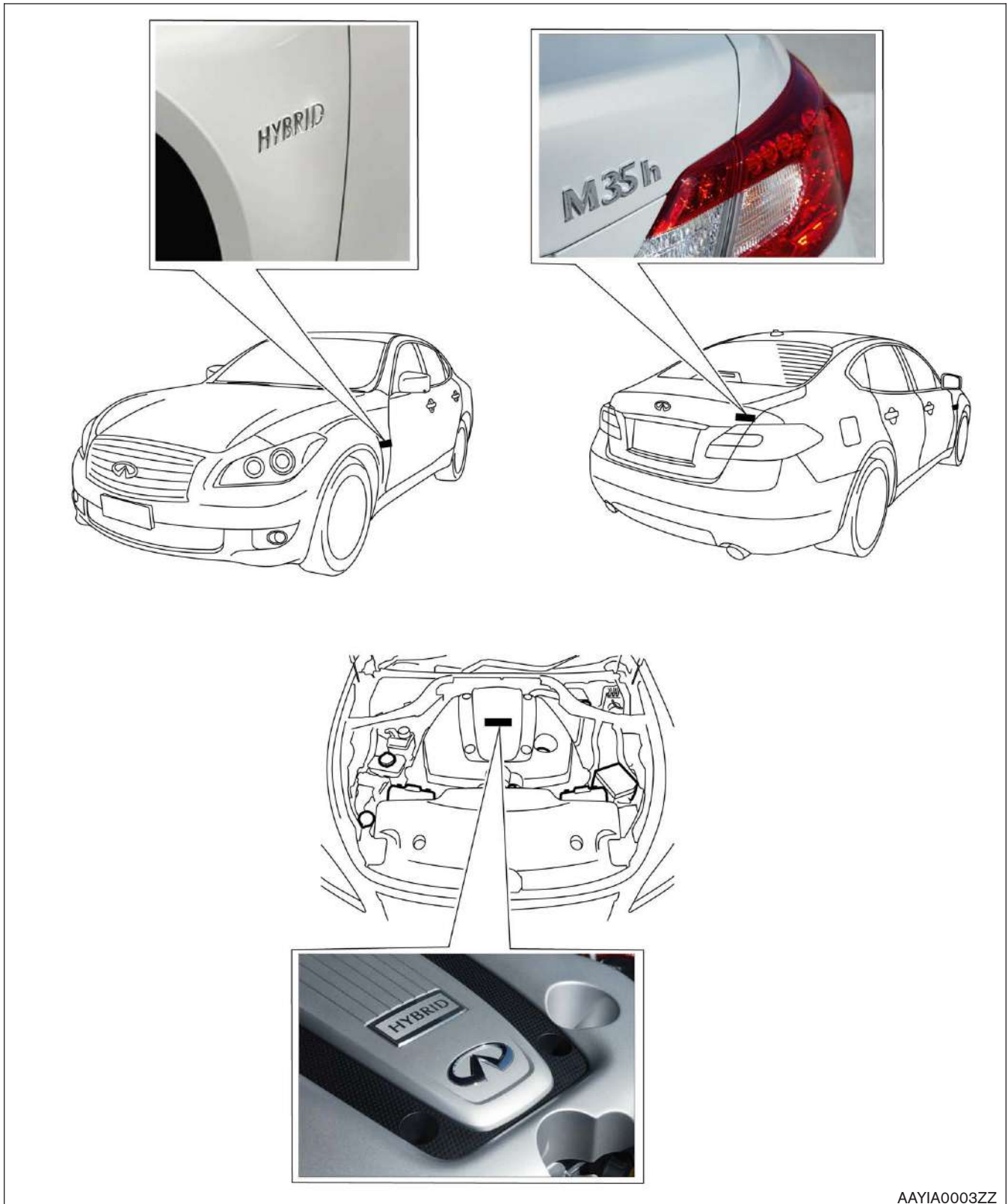

AAZIA0003ZZ

1-1.2 Interior

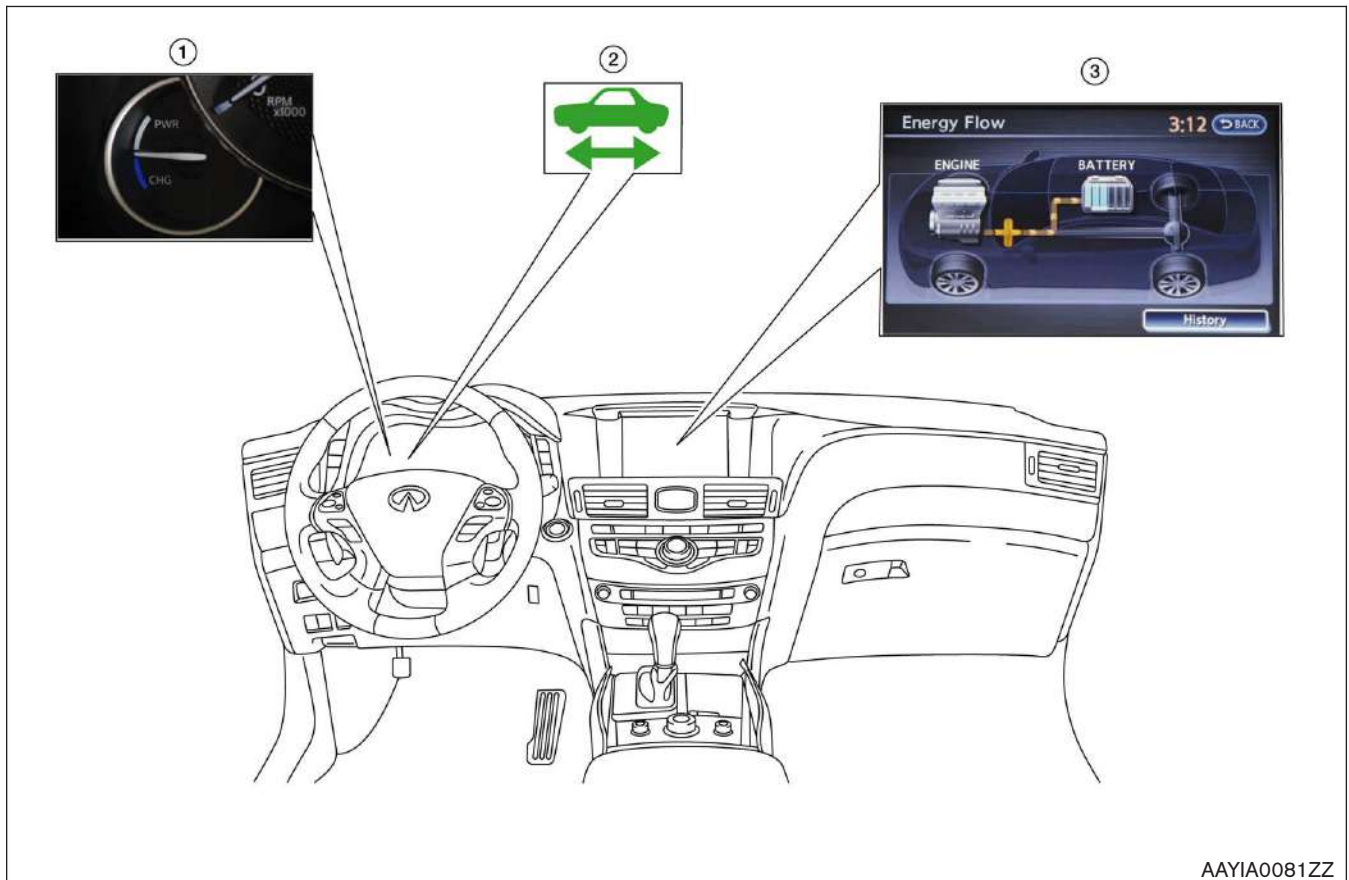

1. Assist charge gauge

2. READY indicator (green)

3. Energy flow display *1

*1: This screen may not be displayed due to customer settings.

1-2 Vehicle Identification Number (VIN) Layout

In exterior appearance the M35h HYBRID is nearly identical to the conventional INFINITI M series vehicles. The vehicle identification number can be located as follows:

Example VIN : JN1**E**Y1APXCM005523

The M35h HYBRID is identified by the 4th alphanumeric character: **E**

E = M35h HYBRID

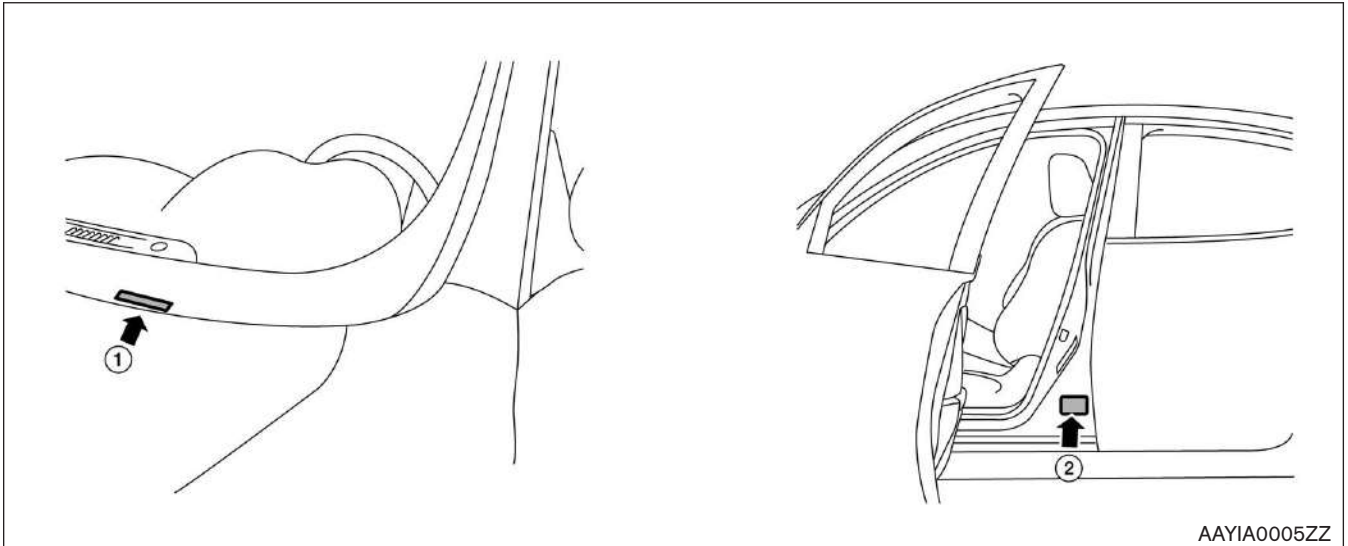

1. VIN plate (visible through windshield)

2. Vehicle certification plate (lower center pillar)

1-3 Warning and Indicator Lamp Information

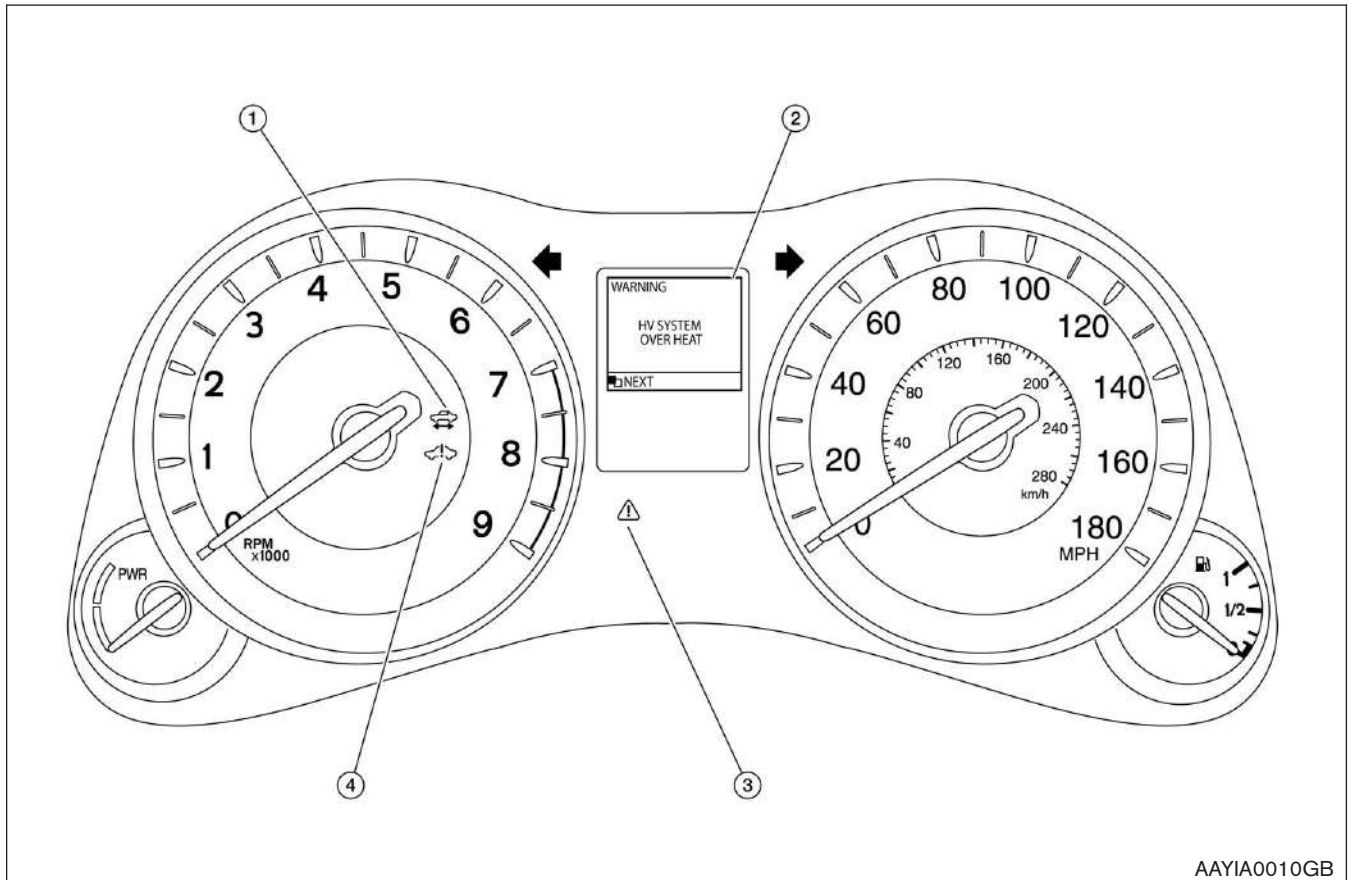



AAYIA0010GB

1. READY Indicator (Green)

2. HV System Overheat Warning (Dot Matrix Liquid Crystal Display)

3. Master Warning Lamp (Orange or Red)

4. Hybrid System Warning Lamp (Orange)

Lamp Name	Icon	Description
READY Indicator (Green)		This lamp is on when the high voltage system is powered up and the vehicle is ready to drive.
Master Warning Lamp (Orange or Red)		This lamp is on when another warning lamp or message is displayed in the instrument cluster.
		

Lamp Name	Icon	Description
Hybrid System Warning Lamp *1 (Orange)		This lamp is on or blinking when: <ul style="list-style-type: none"> ▪ Malfunction has occurred in the high voltage system and/or ▪ High voltage leak to vehicle chassis and/or ▪ Emergency shut-off system has been activated. The shut-off system activates in the following conditions: <ul style="list-style-type: none"> – Front and side collisions in which the air bags are deployed. – Certain rear collisions. – Certain high voltage system malfunctions.

*1: When this lamp is ON, the READY Indicator will turn OFF.

2. Basic High Voltage System and 12V System Information

2-1 Battery Information

The M35h HYBRID utilizes two batteries in order to supply both high and low voltage.

2-1.1 Low Voltage Battery

- The M35h HYBRID contains a conventional lead-acid 12V battery.
- The 12V battery is located in the trunk, left of Li-ion battery, concealed by trim cover.
- The 12V battery is charged by the Li-ion battery through the DC/DC converter.

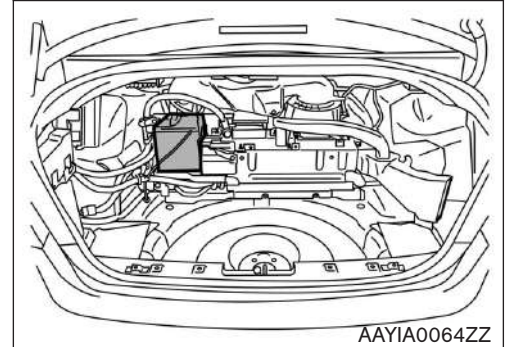

2-1.2 Li-ion Battery

- The M35h HYBRID contains a Li-ion high voltage battery.
- The high voltage battery is mounted in the trunk area behind the rear seat, enclosed in a metal case and concealed by trim cover.
- The high voltage battery stores approximately 346 volts DC (400V max.).
- The high voltage battery exhausts gases directly outside the vehicle through a vent hose.

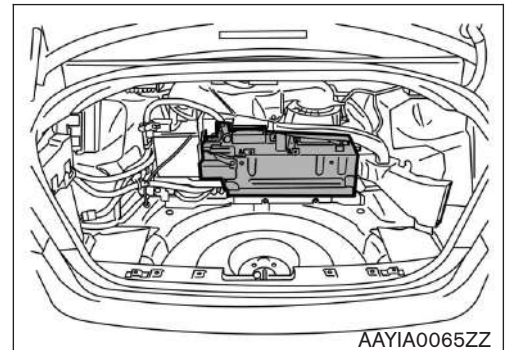

- An air vent is located on the rear parcel shelf for battery cooling.

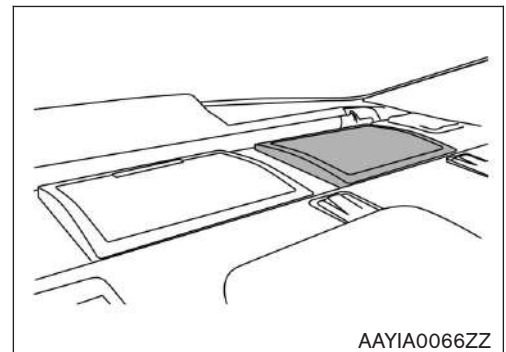

The high voltage battery supplies power to the following:

- High voltage harnesses
- DC/DC converter
- Traction motor inverter
- Traction motor
- Electric air conditioner compressor

2-2 High Voltage-Related and 12V-Related Component Locations and Descriptions

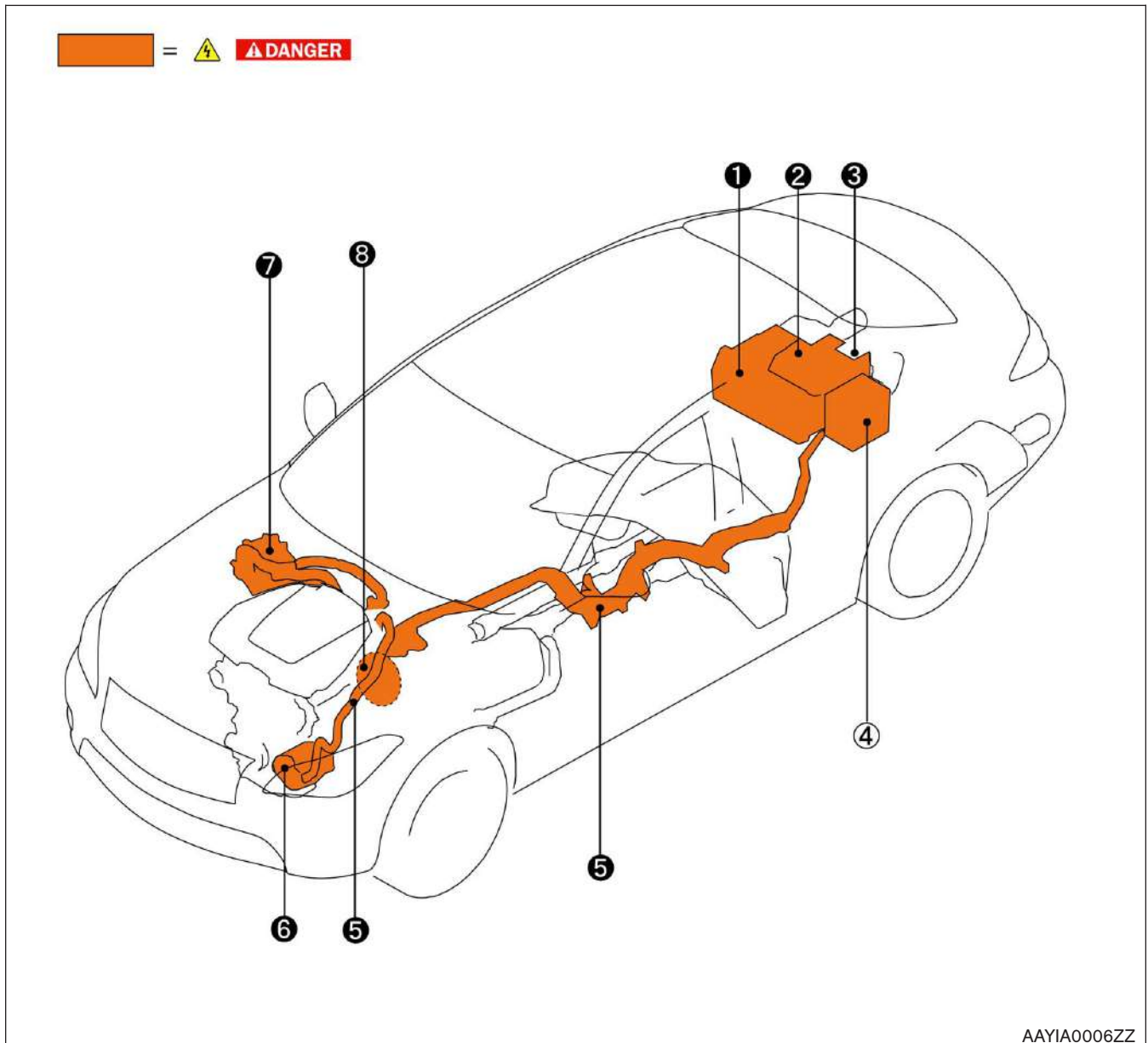

NOTE:

Components with white number in black background are high voltage components.

No.	Component	Location	Description
①	Lithium-ion (Li-ion) Battery	Trunk area (behind rear seat back)	The Li-ion battery stores and outputs DC power (Maximum voltage 400V) needed to propel the vehicle.
②	DC/DC Converter	Trunk area (mounted to top of Li-ion battery)	The DC/DC converter reduces the voltage of the Li-ion battery to provide power to the 12V battery in order to operate the vehicle's electric components (headlights, audio system, etc.).
③	Service Plug	Trunk area (below parcel shelf; behind access door in trim panel)	This is used to disable the high voltage system.
④	12V Battery	Trunk area (below parcel shelf; behind trim panel left of Li-ion battery)	A lead-acid battery that supplies power to the low voltage devices.
⑤	High Voltage Harnesses	Trunk area (on Li-ion battery), under floor pan, engine compartment	Orange-colored power cables carry high DC voltage between each of the high voltage components.
⑥	Electric Air Conditioner Compressor	Engine compartment (front driver side)	Air conditioner compressor
⑦	Traction Motor Inverter	Engine compartment (rear passenger side)	Converts the DC power stored in the Li-ion battery to three-phase AC power and controls motor torque (revolution) by regulating the motor current. The inverter has a built in high voltage capacitor.
⑧	Traction Motor	Built-into the transmission	Converts three-phase alternating current (AC) power to drive power (torque) which propels the vehicle.

2-3 Li-ion Battery Pack Specifications

Li-ion Battery Specifications	
Li-ion battery voltage	346V (400V max.)
Number of Li-ion battery modules in the pack	12
Li-ion battery module voltage	28.8V each
Li-ion battery dimensions	33.35 x 17.83 x 15.43 in. (847 x 453 x 392 mm)
Li-ion battery weight	121.28 lbs (55 kg)

2-4 High Voltage Safety Measures

Circuit insulation	The high voltage positive (+) and negative (-) circuits are insulated from the metal chassis.
Reducing the risk of electrocution	The high voltage components and harnesses have insulated cases or orange-colored coverings which provide insulation and easy identification. The high voltage battery case is electrically connected to the vehicle ground. This connection helps protect the vehicle occupants and emergency responders from high voltage electrical shock.
Identification	The high voltage components are labeled “WARNING” similar to label shown below. All high voltage harnesses are coated in orange.

2-4.1 Warning Label

 WARNING / AVERTISSEMENT		
<p>HIGH VOLTAGE INSIDE DO NOT ATTEMPT TO DISASSEMBLE OR REPAIR. ELECTRIC SHOCK MAY OCCUR.</p> <ul style="list-style-type: none"> • Avoid contacting the batteries and fluid with eyes, skin or clothes. In the event of a spill, flush with water and seek medical help immediately. • Keep children away from this unit • To avoid explosions or fire which can result in serious injury or death: <ul style="list-style-type: none"> • Do NOT immerse in water or allow condensation to occur within the unit • Do NOT touch with wet hands • Do NOT expose to fire or open flame • Do NOT strike or puncture the battery or its housing <p>For Qualified High Voltage Technicians:</p> <ul style="list-style-type: none"> • Read the Service Manual before repairing or replacing the battery • Do not allow metal objects to contact or fall inside the battery. Burns, shock, sparks, explosion or fire may occur due to a sudden increase in internal pressure. <p>HV BATTERY RECYCLING INFORMATION: • TRANSPORT THIS BATTERY IN ACCORDANCE WITH ALL APPLICABLE LAWS. • FOR REPLACEMENT AND DISPOSAL INFORMATION, BE SURE TO CONTACT YOUR NISSAN DEALER OR NISSAN NORTH AMERICA P.O. BOX 685001 FRANKLIN, TN 37068-5001 (800) 647-7261.</p>	<p>HAUTE TENSION À L'INTÉRIEUR NE TENTEZ PAS DE DÉSASSEMBLER OU DE RÉPARER; RISQUE DE CHOC ÉLECTRIQUE.</p> <ul style="list-style-type: none"> • Évitez tout contact des batteries et du fluide avec les yeux, la peau ou les vêtements. En cas de renversement, rincez avec de l'eau et consultez un médecin immédiatement. • Tenez les enfants éloignés de cet équipement. • Pour éviter une explosion ou un incendie pouvant entraîner des blessures graves, voire mortelles: <ul style="list-style-type: none"> • Ne PAS immerger dans l'eau ou permettre la formation de condensation à l'intérieur • Ne PAS toucher avec les mains mouillées • Ne PAS exposer à une source d'inflammation ou des flammes nues • Ne PAS frapper ou percer la batterie ou son boîtier <p>Pour les techniciens qualifiés pour les circuits haute tension :</p> <ul style="list-style-type: none"> • Lisez le manuel d'entretien avant de réparer ou de remplacer la batterie. • Ne permettez à aucun objet métallique d'entrer en contact avec la batterie ou de tomber à l'intérieur. Une augmentation soudaine de la pression interne peut entraîner des brûlures, des chocs ou des étincelles, ou causer une explosion ou un incendie. <p>RENSEIGNEMENTS RELATIFS AU RECYCLAGE DES BATTERIES HAUTE TENSION: • TRANSPORTER CETTE BATTERIE CONFORMEMENT A TOUTES LES LOIS APPLICABLES. • POUR DE PLUS AMPLES RENSEIGNEMENTS SUR LE REMPLACEMENT ET LA MISE AU REBUT, S'ASSURER DE COMMUNIQUER AVEC VOTRE CONCESSIONNAIRE NISSAN OU AVEC NISSAN CANADA INC, 5290 ORBITOR DRIVE MISSISSAUGA ON L4W 4Z5 1(800) 387-0122</p>	

AAYIA0010ZZ

2-5 High Voltage Safety System

The high voltage safety system is intended to help keep vehicle occupants and emergency responders safe from high voltage electricity.

- A high voltage fuse provides short circuit protection inside the high voltage battery.
- The high voltage safety system is insulated from the metal chassis.
- Positive and negative high voltage power cables are connected to the high voltage battery and are controlled by normally open system main relays (SMR1 and SMR2). When the vehicle is shut off, the relays stop electrical flow from leaving the high voltage battery. However, it can take up to ten (10) minutes for the high voltage capacitor to fully discharge.

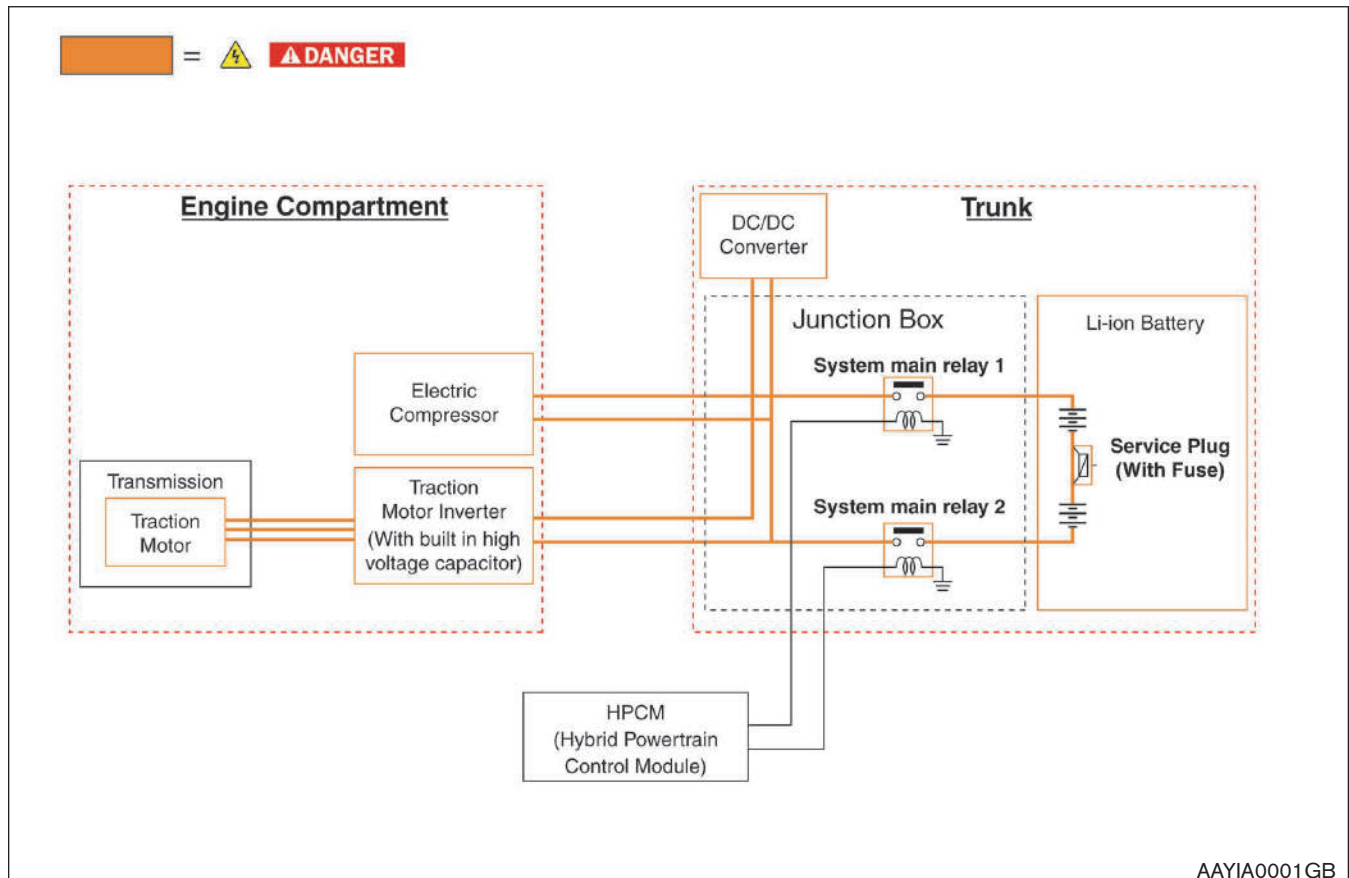

DANGER

- **The high voltage system and high voltage capacitor may remain powered for up to 10 minutes after the vehicle is shut off.**
- **The high voltage battery retains high voltage at all times.**

- A ground fault monitor continuously monitors for high voltage leakage to the metal chassis while the vehicle is running. If a malfunction is detected, the HPCM (hybrid powertrain control module) will illuminate the hybrid system warning lamp  in the instrument cluster.
- The high voltage battery relays (SMR1 and SMR2) will automatically open to stop the electrical flow in a frontal collision that is sufficient enough to activate the supplemental restraint system (SRS).

2-6 High Voltage Circuit Shut-Off System

This vehicle is equipped with a system to shut off the current from the Li-ion battery by the following methods:

Service plug	Positioned in the center area of the Li-ion battery, this plug shuts off the output of high voltage when manually removed.
System main relays	Controlled by the ignition switch, these relays are powered by the 12V system and shut off high voltage from the Li-ion battery.
Emergency shut-off system	In the case of a collision (air bag deployment, etc.) or certain system malfunctions this system shuts off the high voltage from the Li-ion battery.

2-7 Preventing Electrical Shock

1. If it is necessary to touch any of the high voltage harnesses or components, always wear appropriate PPE (refer to [3-1 Preparation Items](#)). Shut off the high voltage system by referring to [3-3.1 High Voltage System Shut-Down Procedure](#).
2. To avoid the risk of electrocution, do not touch the inside of the Li-ion battery with bare hands after shutting off the high voltage system. The Li-ion battery maintains charge even though the high voltage system is shut down.
3. Cover damaged high voltage components with insulated tape.



2-8 Emergency Medical Equipment

The high voltage system should not interfere with emergency medical equipment which must be used in or near the vehicle at an accident scene.



3. Emergency Response Steps







⚠ DANGER

-  Failure to properly shut down the high voltage electrical system before the Emergency Response Procedures are performed will result in serious injury or death from electrical shock. To prevent serious injury or death, **DO NOT** touch high voltage harnesses or components without always wearing appropriate PPE.
-  If it is necessary to touch any of the high voltage harnesses or components you must always wear appropriate PPE to avoid electrical shock. Shut down the high voltage system by following the steps outlined in [3-3.1 High Voltage System Shut-Down Procedure](#). Wait at least ten (10) minutes for complete discharge of the high voltage capacitor after the high voltage system has been shut down.

⚠ WARNING

- **NEVER** assume the M35h HYBRID is shut OFF simply because it is quiet.
- If the READY  indicator is ON the high voltage system is active.
- If possible, be sure to check the READY  indicator on the instrument cluster and verify that the READY  indicator is OFF and the high voltage system is stopped.

3-1 Preparation Items

Preparation Items	Specification	Purpose
PPE (personal protective equipment): Insulated gloves 	Up to 1,000V	For protection from high voltage electrical shock
Insulated shoes 	—	
Safety shield 	—	
Wrenches 	Size:10mm	To remove the 12V battery terminal bolt.
Solvent resistant protection gloves	—	To utilize in the event of a Li-ion battery electrolytic solution leak.
Solvent resistant protection shoes	—	
Absorbent pad	The same pad used for internal combustion engine fluids can be used.	To absorb any Li-ion battery electrolytic solution leakage.
Standard fire fighting equipment	Standard fire fighting equipment. Depending on type of fire (vehicle or battery) use standard fire fighting equipment (water or extinguisher).	To extinguish a fire.
Insulated tape	Insulating	To cover any damaged harnesses to protect from and prevent electrical shock. Tape should cover all bare or damaged wire.

3-1.1 PPE (Personal Protective Equipment) Protective Wear Control

Perform an inspection of the PPE items before beginning work. Do not use any damaged PPE items.

3-1.2 Daily Inspection

This inspection is performed before and after use. The responder who will be using the items should perform the inspection and check for deterioration and damage.

- Insulated rubber gloves should be inspected for scratches, holes and tears. (Visual check and air leakage test)
- Insulated safety boots should be inspected for holes, damage, nails, metal pieces, wear or other problems on the soles. (Visual check)
- Insulated rubber sheet should be inspected for tears. (Visual check)

3-1.3 Insulated Tools

When performing work at locations where high voltage is applied (such as terminals), use insulated tools meeting 1,000V/300A specifications.

3-2 Vehicle Immobilization and Stabilization

Apply the parking brake and stabilize the vehicle with a wheel chock(s) or deflate the tires. Put support material such as wooden blocks or utilize the Lift Airbag Equipment for rescue.

⚠ WARNING

- **To avoid electrical shock, do not put the Lift Airbag Equipment for rescue and wheel chock(s) under the high voltage components and harnesses.**

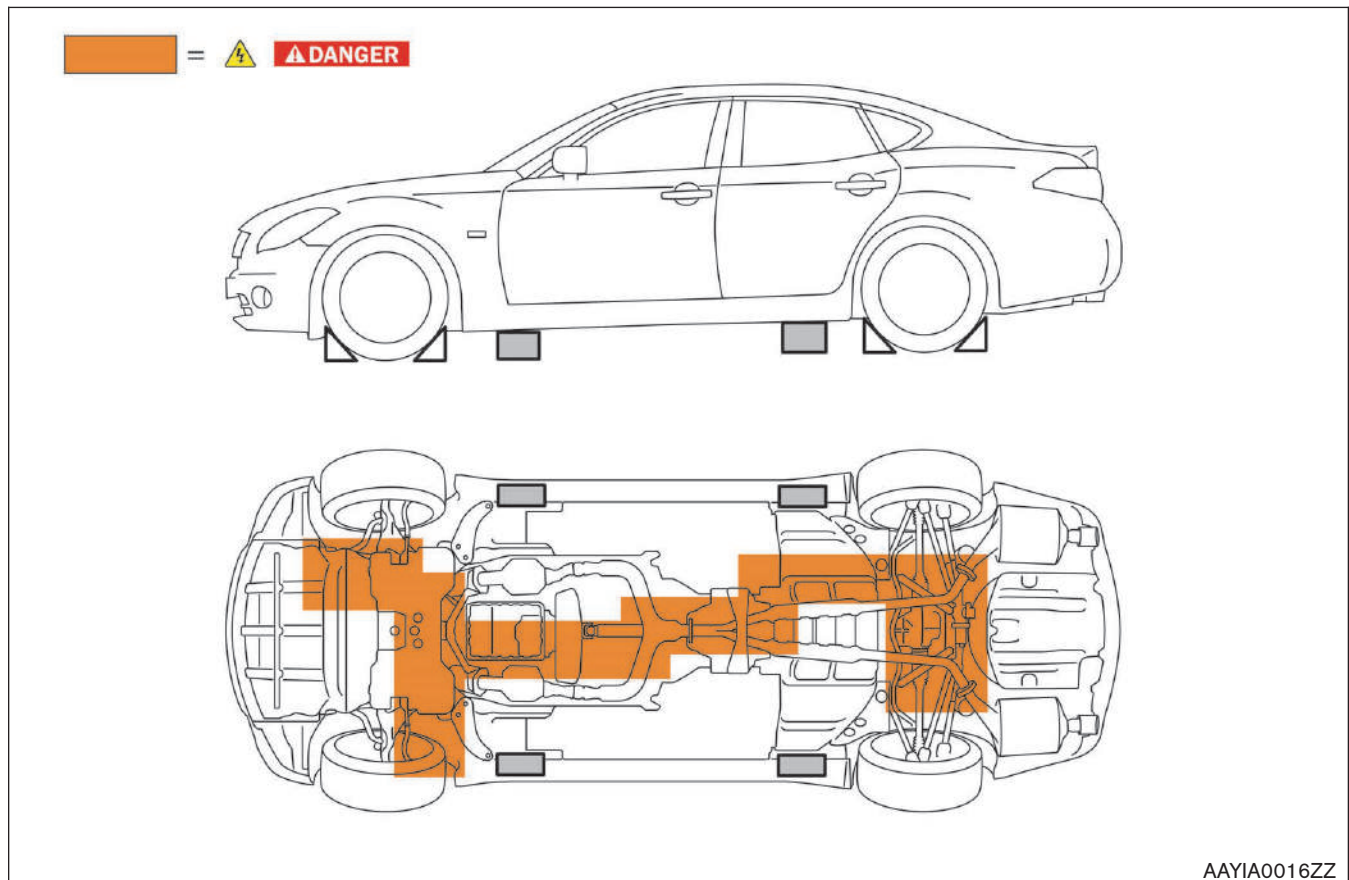

AAYIA0016ZZ

3-3 How to Handle a Damaged Vehicle at an Accident Scene

NOTE:

If any air bags have deployed in the following 3 situations, the high-voltage (HV) system has been automatically shut off at the time of deployment.

The INFINITI M35h HYBRID high-voltage system incorporates capacitors which are energized whenever the high-voltage system is on. If the high-voltage system is shut down (either through one of the built-in automatic mechanisms or manually through one of the procedures explained in this FRG), the capacitors will begin to gradually discharge. After 5 minutes, the voltage level will have dropped below 60V, and complete discharge requires approximately 10 minutes after high-voltage system shut down. It is within this period of time that responders must be most cautious.

When arriving to an incident involving an INFINITI M35h HYBRID, the vehicle should be approached with caution and inspected for the level of damage. In addition to overall vehicle condition (location and severity of body damage, air bag deployment, etc.), the high-voltage system should be assessed specifically. The locations of the high-voltage component parts are illustrated in this FRG. Refer to [2-2 High Voltage-Related and 12V-Related Component Locations and Descriptions](#). Appropriate personal protective equipment (PPE) must always be worn when approaching a vehicle of unknown condition, as described in this FRG.

Situation 1) High voltage system intact, occupants can be accessed without extrication tools

The HV system can be shut down by following the procedure in this guide, while wearing appropriate PPE. After HV system shut down, occupant assistance can begin immediately, and no wait period is necessary.

Situation 2) High voltage system intact, occupants cannot be accessed without extrication tools

The HV system can be shut down by following the procedure in this guide, while wearing appropriate PPE. After HV system shut down, absolute care must be taken not to cut through or damage any HV system wiring, battery or components within ten (10) minutes of HV system shut down, but occupant assistance operations using extrication equipment can begin immediately. The locations of the HV components are illustrated in this guide.

Situation 3) High-voltage (HV) system damaged

If there is any evidence that the HV system has been compromised (such as arcing/sparking, orange wiring harnesses cut or damaged, HV component casings damaged, etc.), the responder may still be at risk of high voltage exposure. The vehicle must be approached with extreme caution prior to initiating any system shut down procedures or rendering assistance to occupants. Appropriate PPE must always be worn as described in this guide, and the ten (10) minute wait time must be observed after HV system shut down in order to ensure the system is de-energized.



In rare situations where vehicle damage is very severe, HV system shut down procedures as described in this guide may not work. In these instances extreme caution and appropriate risk management must be followed to prevent shock or electrocution to the responder or occupant.

3-3.1 High Voltage System Shut-Down Procedure

Any of the following procedures can shut down the high voltage system. The first response operation should only begin after shutting down the high voltage system. If the vehicle is heavily damaged, for example the Li-ion battery is deformed, broken or cracked, appropriate PPE must always be used and the Li-ion battery and high voltage components must not be touched.



DANGER

-  **Failure to properly shut down the high voltage system before the Emergency Response Procedures are performed will result in serious injury or death from electrical shock. To prevent serious injury or death, DO NOT touch high voltage harnesses or components without always wearing appropriate PPE.**
-  **When contact with high voltage components or high voltage harnesses is unavoidable, or when there is risk of such contact, you must always wear appropriate PPE.**

⚠ WARNING

- **⚠ The vehicle contains parts that contain powerful magnets. If a person who is wearing a pacemaker or other medical device is close to these parts, the medical device may be affected by the magnets. Such persons must not perform work on the vehicle.**
- **Be sure to check the READY indicator (1) in the instrument cluster, and verify that the READY indicator is off and the high voltage system is stopped.**

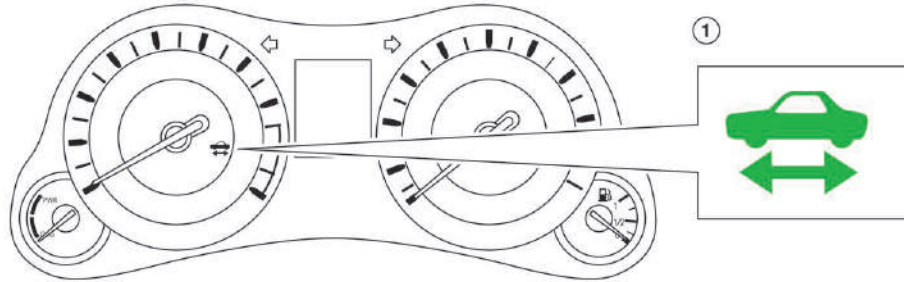

- **After the high voltage system is shut down, please wait for ten (10) minutes for complete discharge of the high voltage capacitor. While waiting, do not operate any vehicle functions.**

NOTE:

The high voltage full discharge takes ten (10) minutes, but after five (5) minutes the voltage has dropped below 60V.

- **Remove the 12V battery negative (-) terminal and wait for three (3) minutes to discharge the air bag capacitor. Even though the 12V battery negative (-) is disconnected, the Supplemental Restraint System (SRS) air bag maintains voltage for three (3) minutes. There is a possibility of sudden SRS air bag inflation due to harness short circuit or damage and it may cause serious injuries.**
- **The 12V system will remain active even after the 12V battery negative (-) terminal is removed while the high voltage system is active. This is because the DC/DC converter will not shut down and power will be supplied to the 12V system and high voltage system continuously.**

Before disconnecting the 12V battery terminal, if necessary, lower the windows, adjust the steering column, adjust the seats, unlock the doors, open the trunk, etc. as required. Once the 12V battery is disconnected, power controls will not operate.

Powering Down the High Voltage System

The high voltage system can be shut down with any 1 of the following procedures:

- Turn OFF the power switch and disconnect the 12V battery. Refer to [Primary Procedure](#).
- Remove the fuse for the high voltage control system and disconnect the 12V battery. Refer to [Alternate Procedure 1](#).
- Remove the service plug and disconnect the 12V battery. Refer to [Alternate Procedure 2](#).

Primary Procedure

NOTE:

Before disconnecting the 12V battery terminal, if necessary, lower the windows, adjust the steering column, adjust the seats, unlock the doors, etc. Once 12V battery is disconnected, power controls will not operate.

1. Check the READY indicator (A) status in the instrument cluster. If it is on, the high voltage system is active.

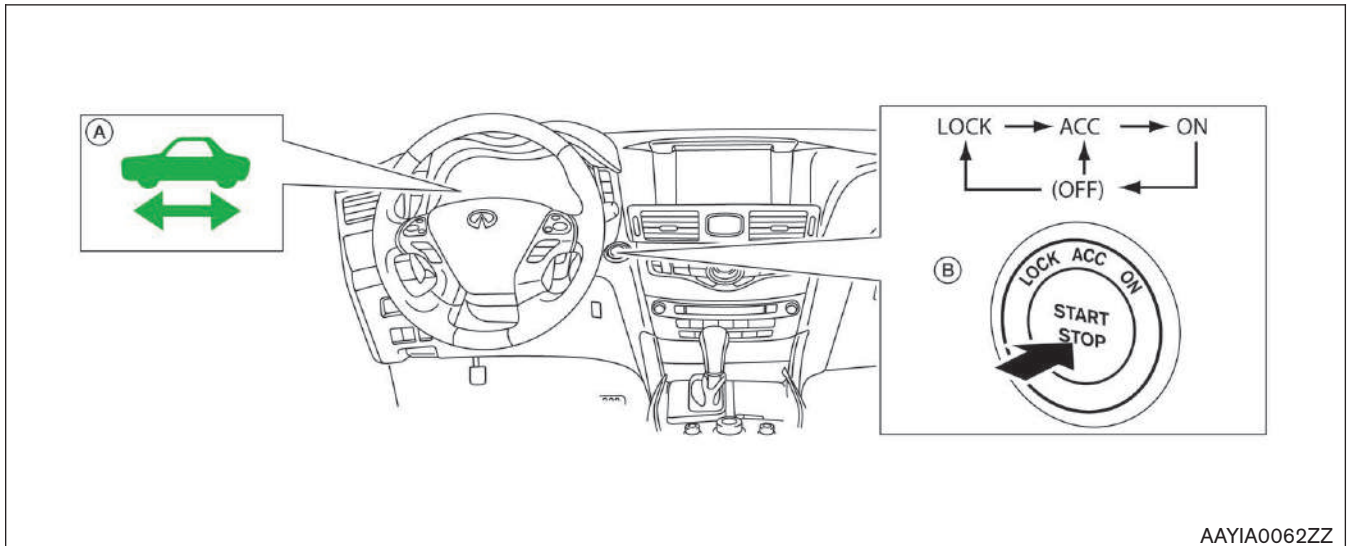

2. Place the shift selector in the Park (P) position.
3. Push the ignition switch (B) once to turn OFF the high voltage system. Then verify whether the READY indicator (A) is off.

If the READY indicator (A) does not turn off, continue to the next steps to open the trunk for 12V battery negative cable access.

4. If possible, keep the INFINITI Intelligent Key™ at least 5 meters (16 feet) away from the vehicle (except as noted below).
5. Open the trunk using any of the following:
 - a. push-button switch (C) on the lower LH side of the instrument panel.
 - b. trunk button (D) on the INFINITI Intelligent Key™ [press for longer than one (1) second].
 - c. trunk open request switch (E) (located above license plate)*.
 - d. with the mechanical key (F) housed inside the INFINITI Intelligent Key™.

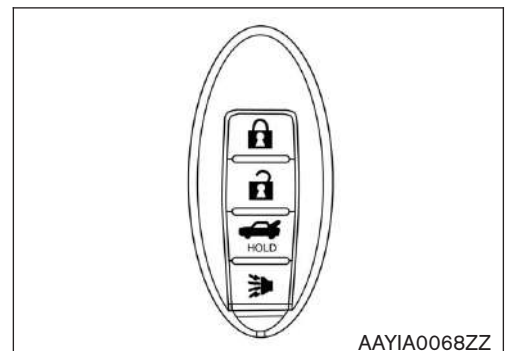

* You must have the INFINITI Intelligent Key™ within approximately 1 meter (3 feet) range of trunk request switch to use the trunk open request switch function.

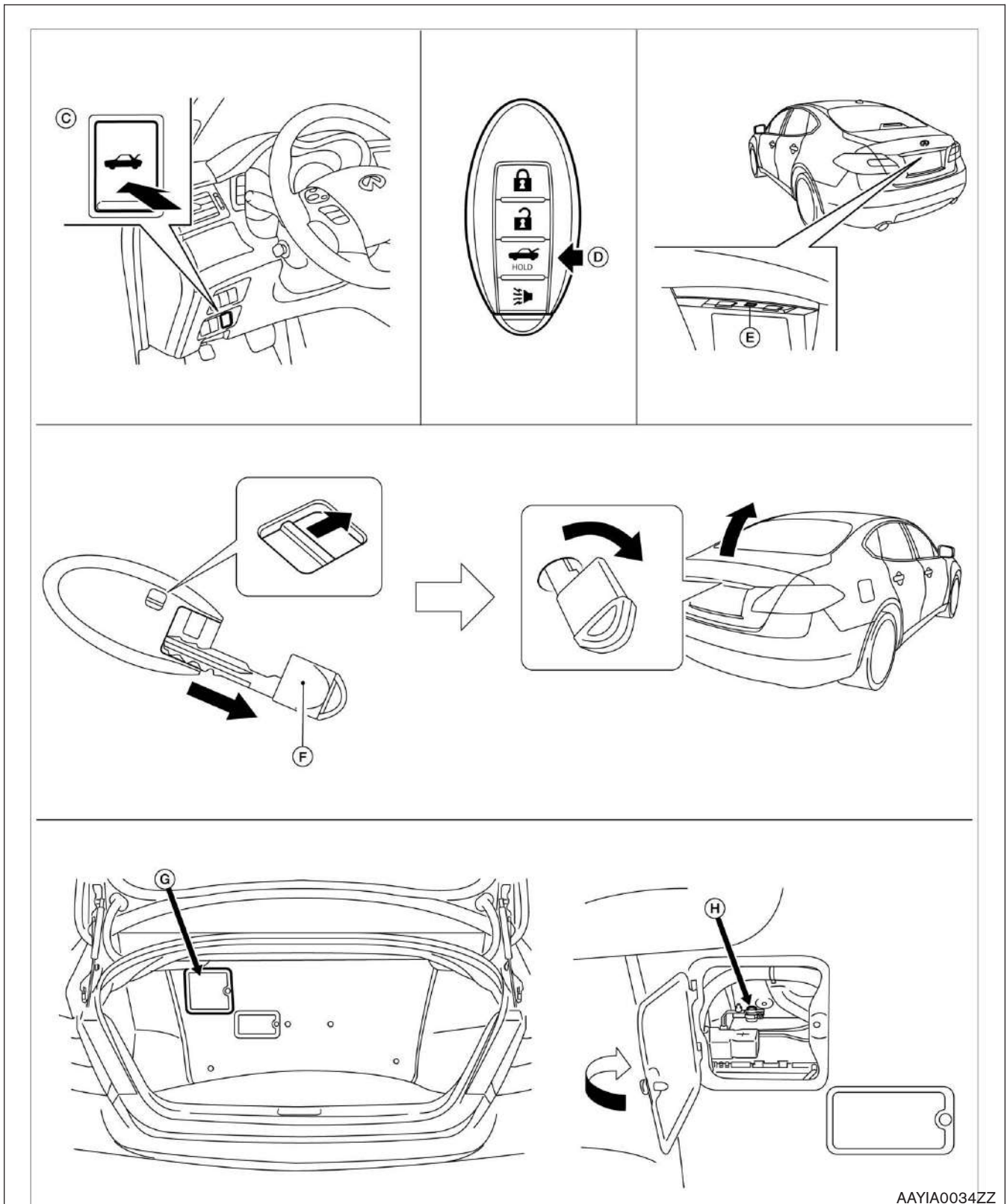

AAYIA0034ZZ

6. Open the 12V battery service access cover (G).
7. Disconnect negative (-) battery cable (H) and cover it with insulated tape.
8. Wait ten (10) minutes for complete discharge of the high voltage capacitor after the battery cable has been disconnected.
9. Perform the first response action.

Alternate Procedure 1

NOTE:

Before removing any fuses, if necessary, lower the windows, adjust the steering column, adjust the seats, unlock the doors, etc. Once fuses are removed, power controls will not operate.

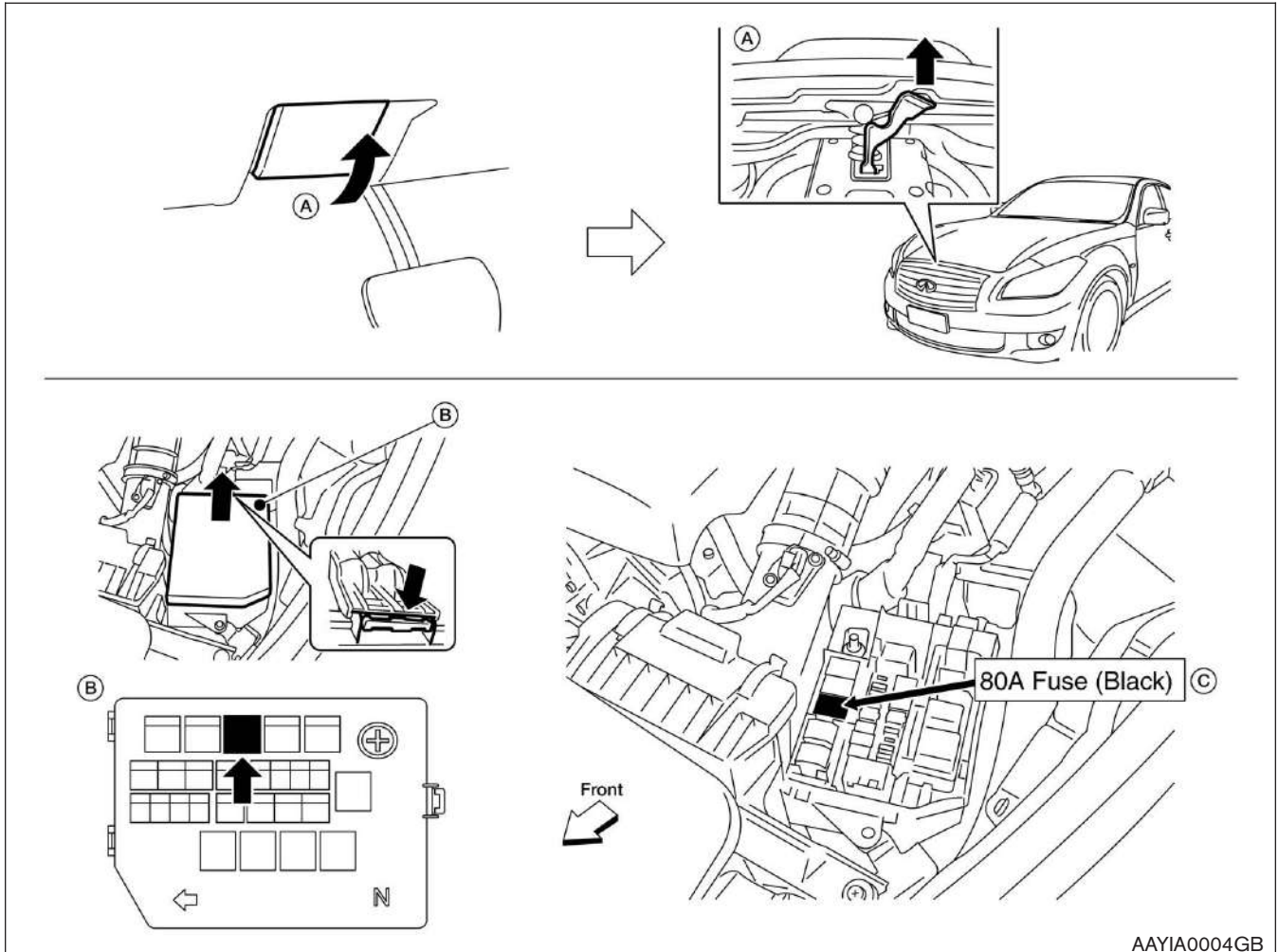

AAYIA0004GB

1. Pull release handle (A) to open the hood.
2. Remove fuse box cover (B).
3. Remove 80A fuse (C) (black).
4. If you cannot identify the fuse (C), remove all fuses in the fuse box.

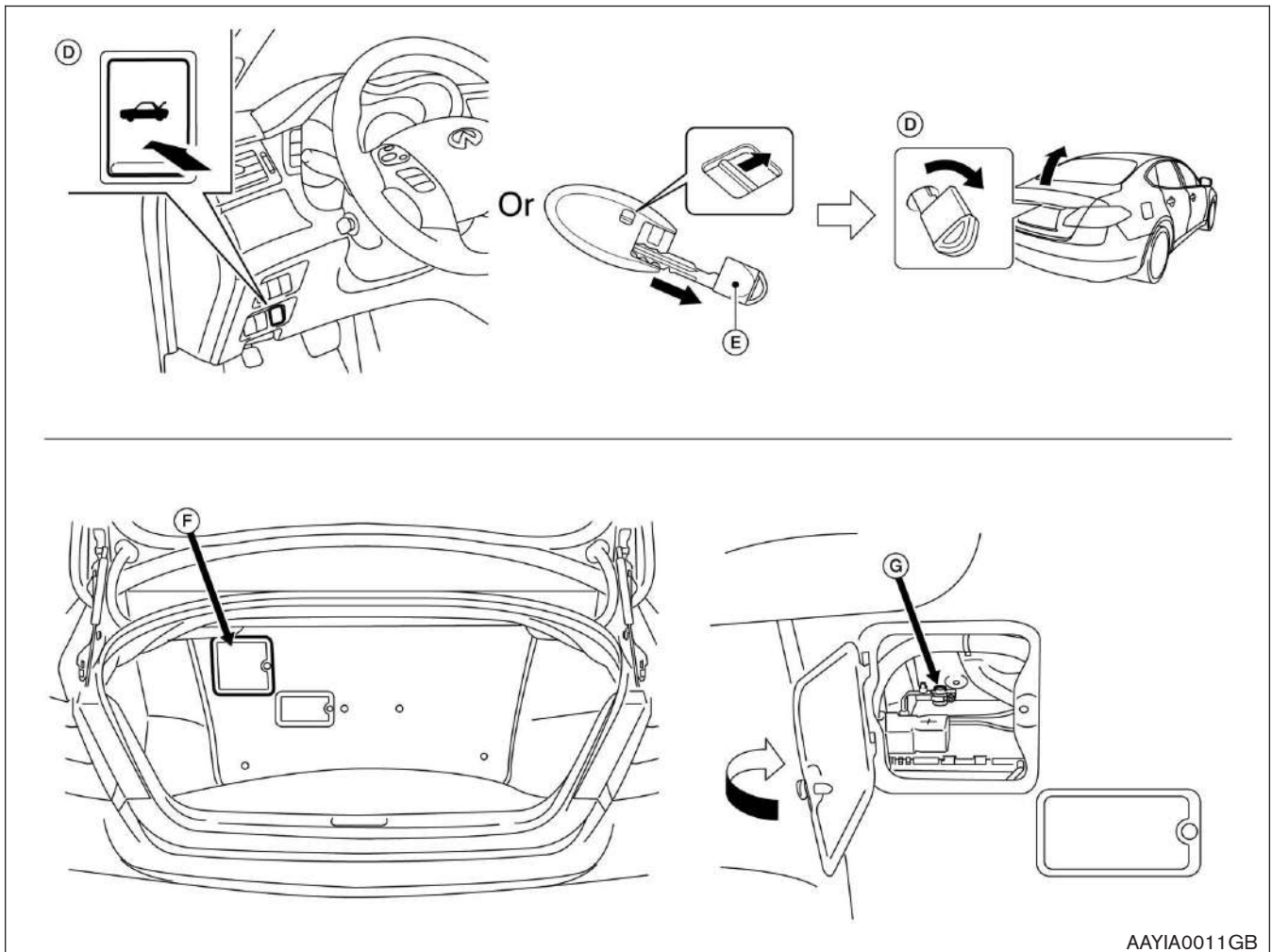

AAYIA0011GB

5. Open the trunk. The trunk can be opened with the push-button switch (D) on the lower LH side of the instrument panel or with the mechanical key (E) housed inside the INFINITI Intelligent Key™.
6. Open the 12V battery service access cover (F).
7. Disconnect negative (-) battery cable (G) and cover it with insulated tape.
8. Wait ten (10) minutes for complete discharge of the high voltage capacitor after the fuse is pulled and battery cable has been disconnected.
9. Perform the first response action.

Alternate Procedure 2



DANGER

- Do not remove the service plug without always wearing appropriate PPE to help protect the responder from serious injury or death by electrical shock.
- Immediately cover the service plug socket with insulated tape. To avoid electric shock, **DO NOT** touch the terminals inside the socket.

WARNING

To avoid unintended reinstallation and risk of electrical shock and severe personal injury or death, the rescuer should carry the service plug on his/her person while work is in progress.

NOTE:

Before disconnecting the 12V battery terminal, if necessary, lower the windows, adjust the steering column, adjust the seats, unlock the doors, etc. Once 12V battery is disconnected, power controls will not operate.

1. Check the READY indicator (A) status in the instrument cluster. If it is on, the high voltage system is active.

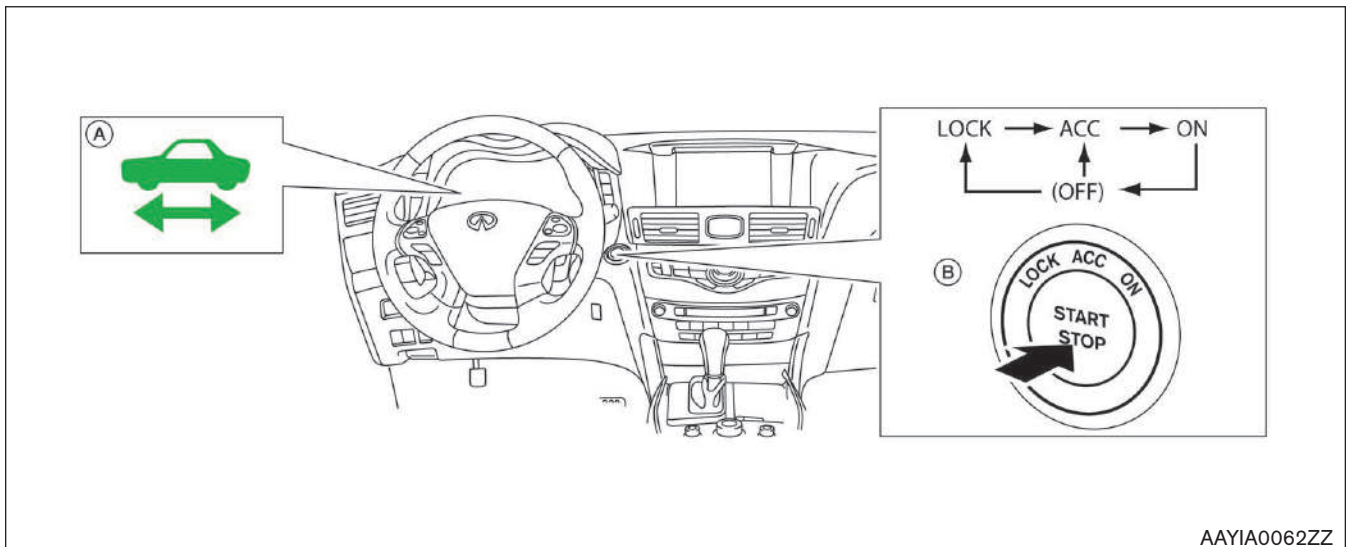

2. Place the shift selector in the Park (P) position.
3. Push the ignition switch (B) once to turn OFF the high voltage system. Then verify whether the READY indicator (A) is off.

If the READY indicator (A) does not turn off, continue to the next steps to open the trunk for 12V battery negative cable access.

4. If possible, keep the INFINITI Intelligent Key™ at least 5 meters (16 feet) away from the vehicle (except as noted below).
5. Open the trunk using any of the following:
 - a. push-button switch (C) on the lower LH side of the instrument panel.
 - b. trunk button (D) on the INFINITI Intelligent Key™ [press for longer than one (1) second].
 - c. trunk open request switch (E) (located above license plate)*.
 - d. with the mechanical key (F) housed inside the INFINITI Intelligent Key™.

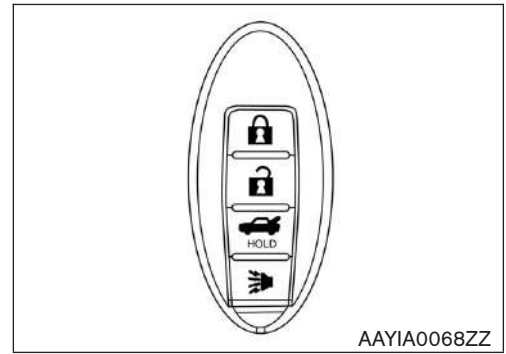

* You must have the INFINITI Intelligent Key™ within approximately 1 meter (3 feet) range of trunk request switch to use the trunk open request switch function.

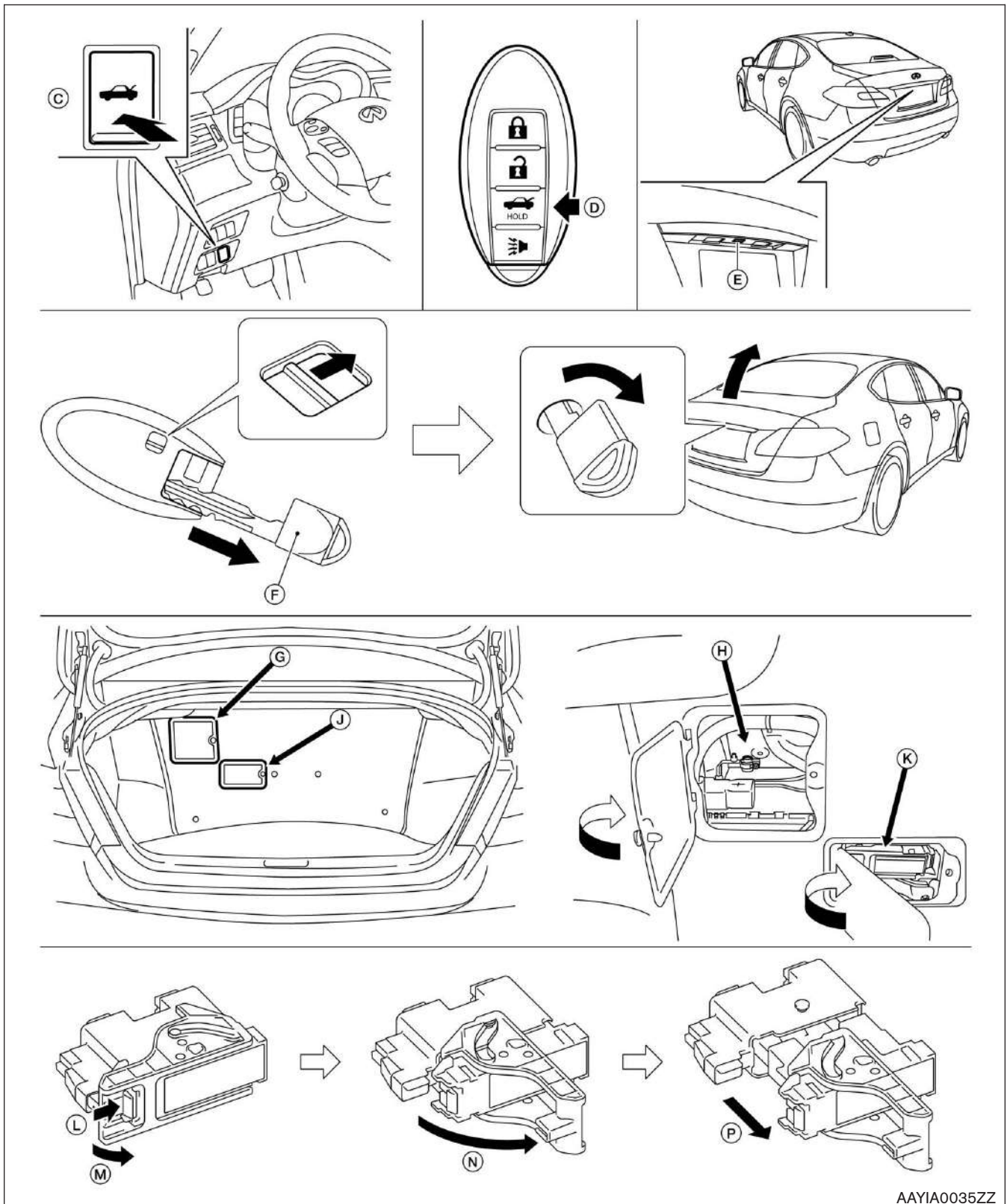

AAYIA0035ZZ

6. Open the 12V battery service access cover (G).
7. Disconnect negative (-) battery cable (H) and cover it with insulated tape.
8. Open service plug access cover (J).
9. Remove the service plug (K) by pressing the locking tab (L) and rotating the handle (M) fully outward (N). Using the handle, pull the service plug (P) completely out of its socket.

10. Wait ten (10) minutes for complete discharge of the high voltage capacitor after the service plug has been removed.
11. Perform the first response action.

3-3.2 Water Submersion





▲ DANGER



Damage level of submerged vehicle may not be apparent. Handling a submerged vehicle without appropriate PPE will result in serious injury or death from electrical shock.

▲ WARNING

-  **The ignition switch of the submerged vehicle must be turned OFF first, if possible. Then the vehicle must be completely out of the water and drained to avoid electrical shock.**
-  **Always wear appropriate PPE and remove/drain water before removing the service plug when working on a vehicle after a fire or submersion to avoid electrical shock.**
-  **If the vehicle is in the water, to avoid electrical shock do not touch the high voltage components, harnesses or service plug.**

3-3.3 Vehicle Fire

▲ WARNING

- **Always utilize full PPE and self-contained breathing apparatus during fire fighting operations. Smoke from a M35h HYBRID vehicle fire is similar to smoke from a conventional vehicle fire.**
- **In the case of extinguishing a fire with water, large amounts of water from a fire hydrant (if possible) must be used. DO NOT extinguish fire with a small amount of water.**

▲ CAUTION

In the event of a small fire, a Type ABC fire extinguisher may be used for an electrical fire caused by wiring harnesses, electrical components, etc. or oil fire.

Fire attack should follow standard fire fighting practices.



If you must walk away from the vehicle, notify an appropriate responder or a rescue person of the fact that the vehicle is a hybrid vehicle and contains a high voltage system and warn all others.

During overhaul operations (late stage fire suppression process to examine for remaining sources of heat), make sure the battery is fully cooled to avoid fire re-ignition. The battery could reignite if it is placed near fire. To avoid possible electrical shock and serious personal injury, do not breach the Li-ion battery case.

3-3.4 Cutting the Vehicle Body



DANGER

-  Do not cut into high voltage related areas to avoid severe personal injury or death.
-  Do not cut into the Li-ion battery to avoid severe personal injury or death.
-  When removing parts, **DO NOT** touch the high voltage parts or the insides of the exposed orange-colored high voltage cables to avoid severe personal injury or death.

WARNING

- Do not cut air bag parts to avoid unintended deployment of the air bags and the risk of severe personal injury or death.

If ten (10) minutes have passed since the rescuer shut down the high voltage system (refer to [3-3.1 High Voltage System Shut-Down Procedure](#)), then the rescuer can cut the vehicle except for the Li-ion battery.

If the rescuer cannot wait the full ten (10) minutes or shut down the high voltage system, absolute care must be taken to avoid cutting HV parts and appropriate PPE must always be worn. DO NOT cut the Li-ion battery due to possible electrocution risk and electrolyte solution leakage.

SRS Air Bag System Components Location

Avoid cutting air bag system parts. However, the vehicle can be cut (except inflators) under the following conditions:

- The front, side and curtain air bags have deployed.
- At least three (3) minutes have passed after the 12V battery negative (-) cable has been disconnected and the high voltage system has been shut down.

 = Inflators (Peel back plastic trim parts prior to cutting operations to confirm exact inflator location.)

 = Sensors

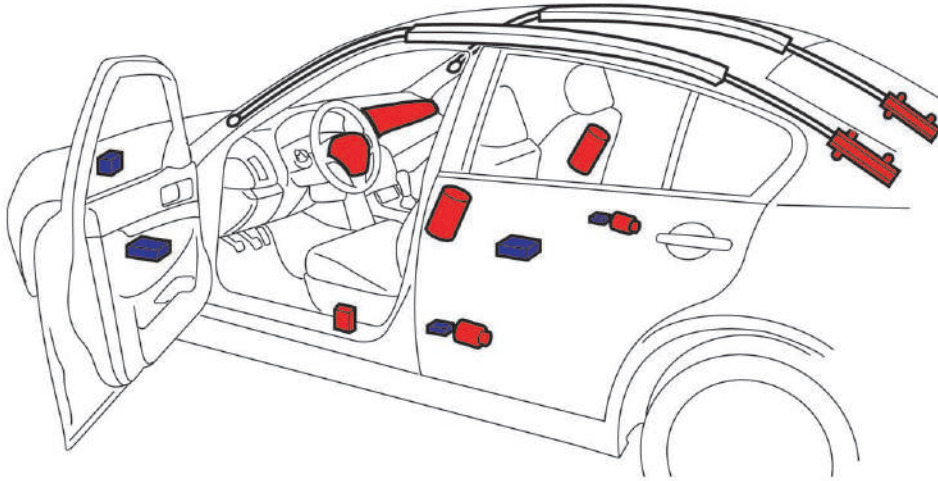

AAYIA0012GB

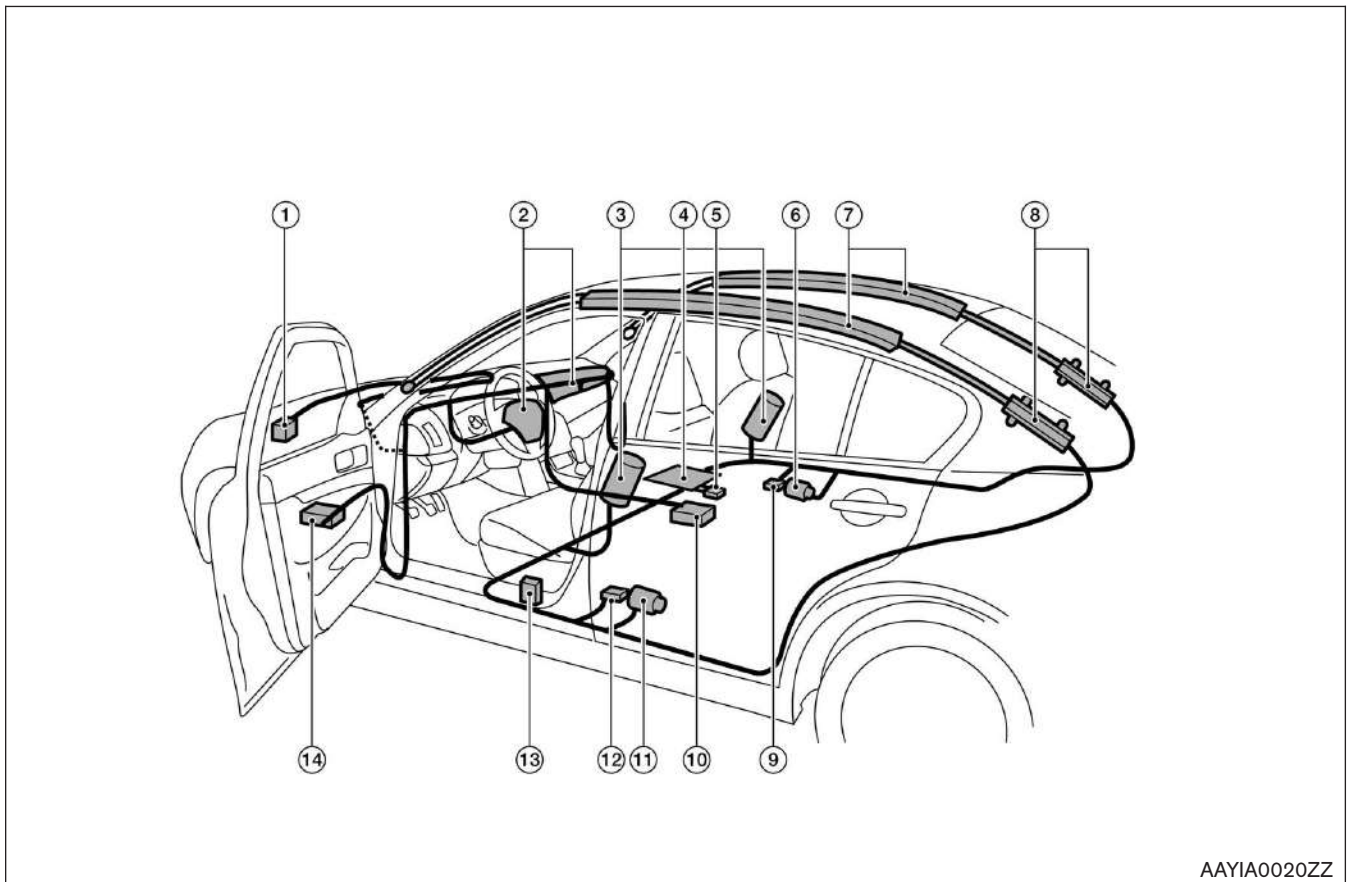

AAZIA0020ZZ

- | | | |
|---|--|---|
| 1. Crash zone sensor | 2. Supplemental front air bag modules (INFINITI Advanced Air Bags) | 3. Front seat-mounted side-impact supplemental air bags |
| 4. Occupant classification sensor (pattern sensor) | 5. Occupant classification system control unit | 6. RH seat belt with pretensioner |
| 7. Roof-mounted curtain side-impact supplemental air bags | 8. Roof-mounted curtain side-impact supplemental air bag inflators | 9. RH satellite sensor |
| 10. Air bag control unit (ACU) | 11. LH seat belt with pretensioner | 12. LH Satellite sensor |
| 13. Lap outer pretensioner (if so equipped) | 14. Front door satellite sensor LH (RH similar) | |

INFINITI Emergency Contact

1-800-662-6200 (US) or 1-800-361-4792 (Canada)
 Hours of Operation: 8am-5pm (Monday-Friday) Eastern,
 Central and Pacific Time Zones

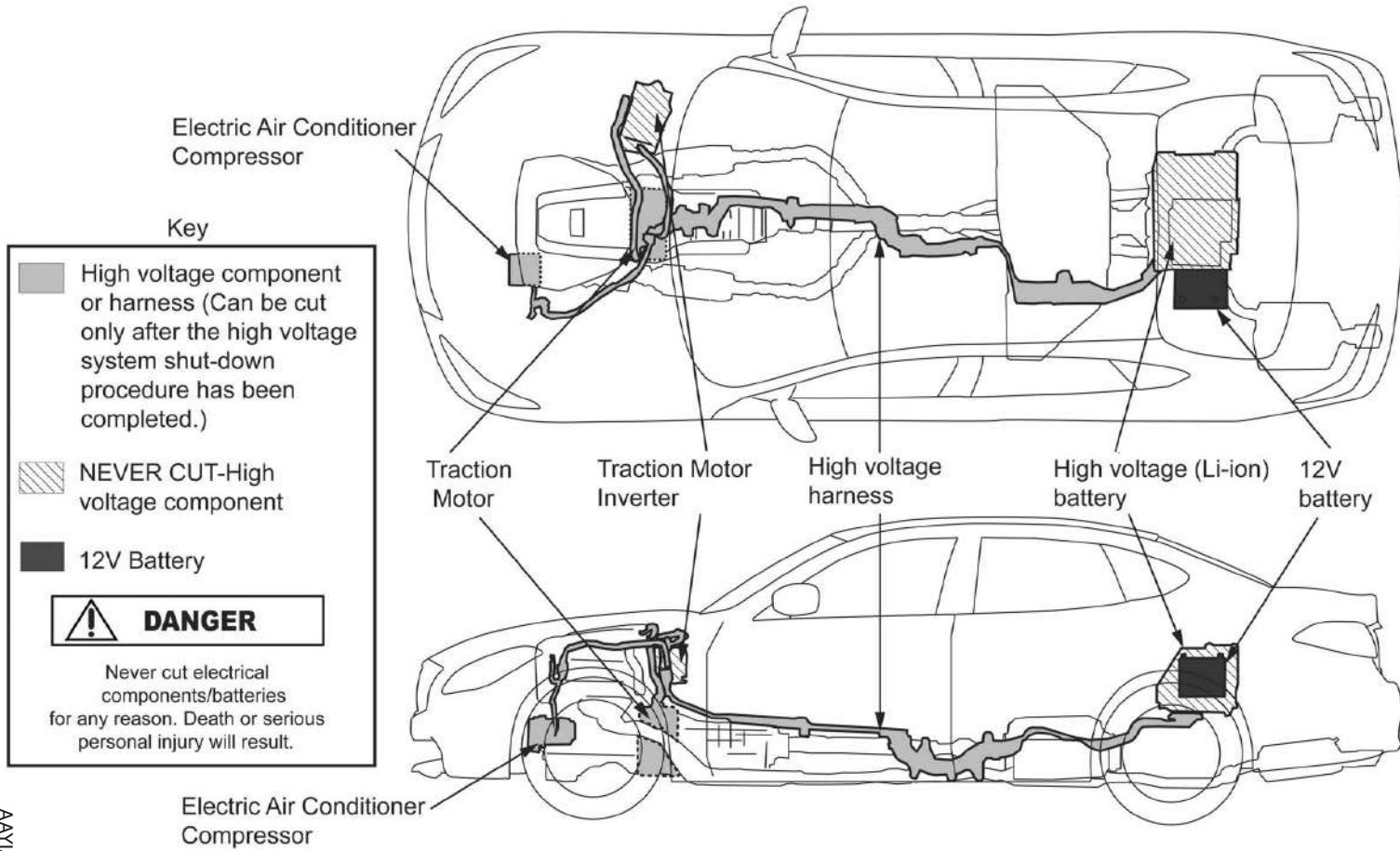

AA1Y1A00005GB

Nissan North America, Version (3)

April 2012

High Strength Steel Locations

-  = High strength steel
-  =  **DANGER**

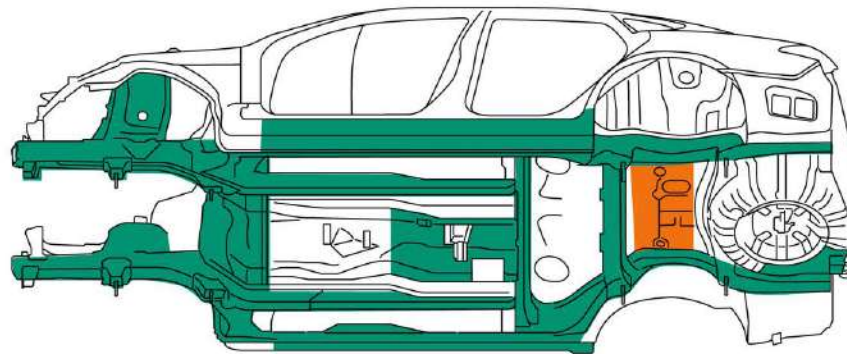
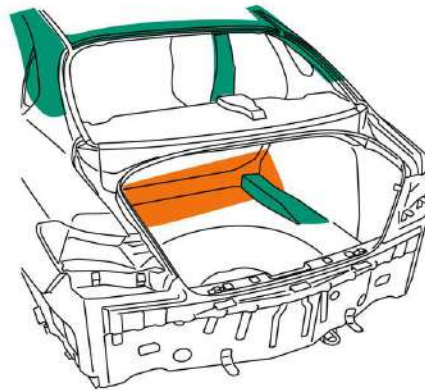
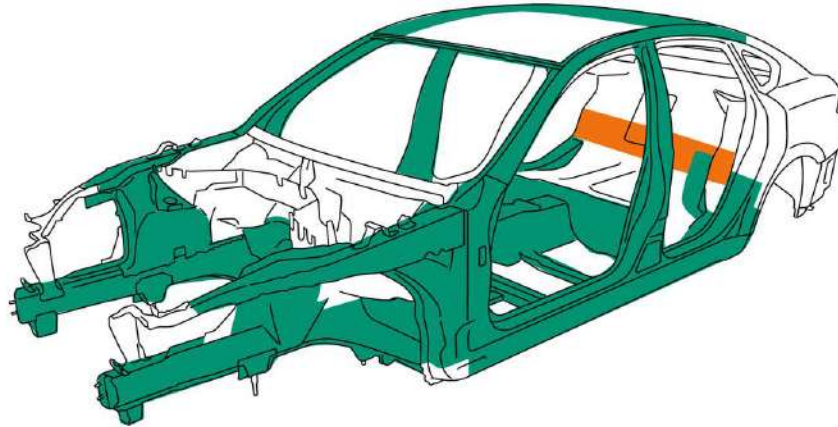

AAYIA0013GB

3-3.5 Li-ion Battery Damage and Fluid Leaks

If electrolyte solution leakage, or damage such as any problem with the Li-ion battery casing are observed, first responders should attempt to neutralize the battery by applying a large volume of water to the battery pack while wearing appropriate PPE. The neutralization process helps stabilize the thermal condition of the battery pack but does not discharge the battery.

Li-ion Battery Electrolyte Solution Characteristics:

- Clear in color
- Sweet odor
- Similar viscosity to water
- Skin irritant
- Eye irritant – If contact with eyes, rinse with plenty of water and see a doctor immediately.
- If electrolyte leak occurs, wear appropriate solvent resistant PPE and use a dry cloth to clean up the spilled electrolyte. Be sure to adequately ventilate the area.
- Highly flammable
- Electrolyte liquid or fumes that have come into contact with water vapors in the air will create an oxidized substance. This substance may irritate skin and eyes. In these cases, rinse with plenty of water and see a doctor immediately.
- Electrolyte fumes (when inhaled) can cause respiratory irritation and acute intoxication. Move to fresh air and wash mouth with water. See a doctor immediately.
- Since the Li-ion battery is made up of many small sealed battery modules, electrolyte solution leakage should be minimal.

NOTE:

Other fluids in the vehicle (such as engine oil, washer fluid, brake fluid, coolant, etc.) are the same as those in a conventional vehicle.

3-3.6 Accessing the Occupants

1. Remove windows
 - a. Perform window removal the same as a normal vehicle.
2. Remove doors
 - a. The doors are removable with hand tools or basic rescue tools such as electrical/hydraulic rescue tools. It may be easier to remove the doors by cutting door hinges.
3. Adjust steering wheel and front seat position (if necessary) as shown below:

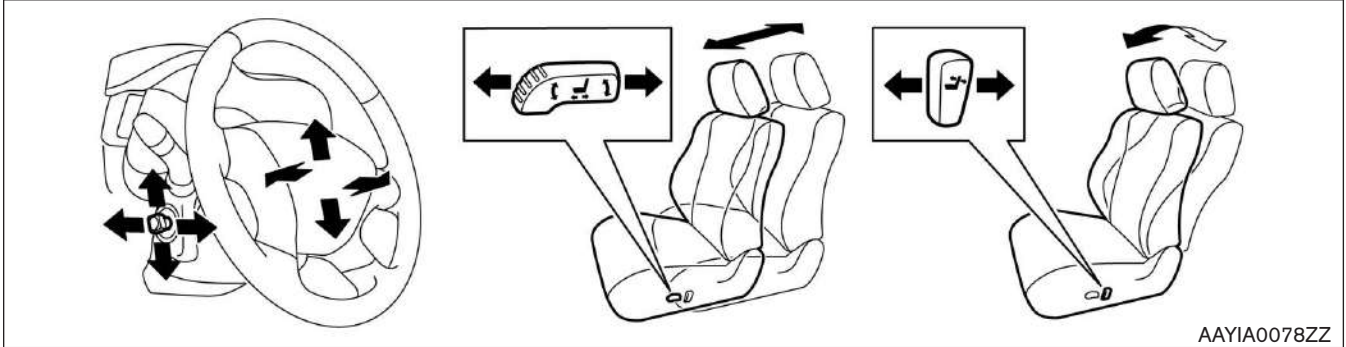

4. Remove front seat head restraint (if necessary).

The front seat head restraint can be removed by pressing the lock knob and pulling it up.

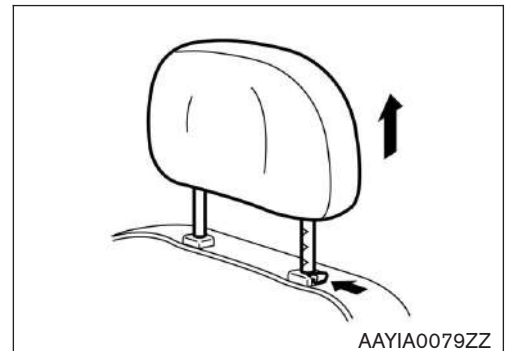

5. Unfasten the seat belt.

Seat belt can be unfastened by pressing the release button. If seat belt cannot be unfastened, cut it with a belt cutter.

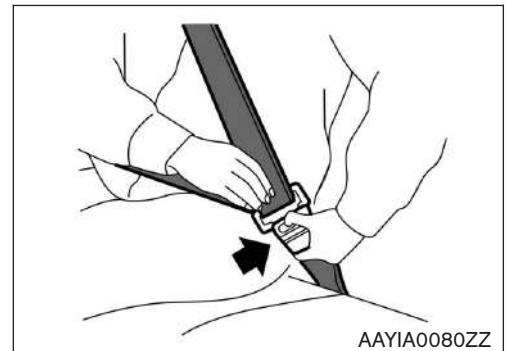

4. Emergency Quick Reference Guide

The following is for emergency quick reference only. It does not replace the detailed safety information and procedures in this manual.

2013 INFINITI M35h

Emergency Responder's Quick Reference Guide

The following is for emergency quick reference only. It does not replace the detailed safety information and procedures in the First Responder's Guide (FRG).

VEHICLE IDENTIFICATION



WARNING AND INDICATOR LAMPS

LAMP NAME	ICON	DESCRIPTION
READY Indicator (Green)		This lamp is on when the high voltage system is powered up and the vehicle is ready to drive.
Master Warning Lamp (ORANGE or RED)		This lamp is on when another warning lamp or message is displayed in the instrument cluster.
Hybrid System Warning Lamp*1 (ORANGE)		<p>This lamp is on when:</p> <ul style="list-style-type: none"> • Malfunction has occurred in the high voltage system and/or • High voltage leak to vehicle chassis and/or • Emergency shut-off system has been activated. The shut-off system activates in the following conditions: <ul style="list-style-type: none"> - Front and side collisions in which the air bags are deployed. - Certain rear collisions. - Certain high voltage system malfunctions.

HIGH VOLTAGE (HV) PARTS LOCATIONS

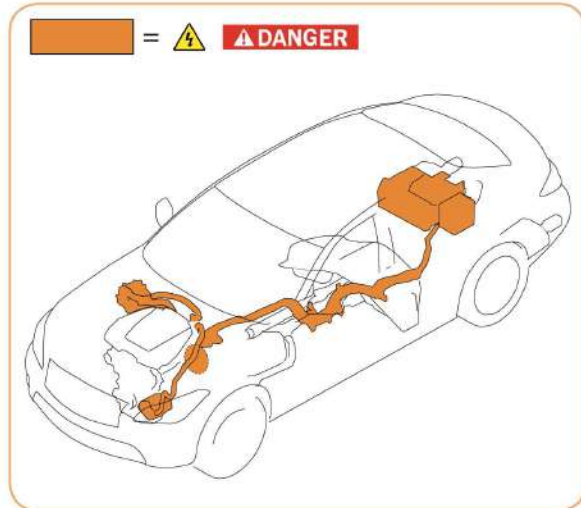

*1: When this lamp is ON, the READY lamp will turn OFF.

2013 **INFINITI** M35h

Emergency Responder's Quick Reference Guide

The following is for emergency quick reference only. It does not replace the detailed safety information and procedures in the First Responder's Guide (FRG).

VEHICLE SHUT-DOWN

Appropriate PPE must always be worn during these procedures and while working on or near high voltage components, battery or harnesses!

PRIMARY PROCEDURE

- 1.** Turn Power Switch OFF.



- 2.** Verify READY indicator is OFF.



- 3.** If possible, keep the Intelligent Key™ at least 5 meters (16 feet) away.



- 4.** Open Trunk and Remove Negative Battery Cable.



ALTERNATE PROCEDURE 1.

- 1.** Open Trunk and Remove Negative Battery Cable.



- 2.** Remove Fuse.



Release tab to remove fuse panel cover.

Q2

2013 INFINITI M35h

Emergency Responder's Quick Reference Guide

The following is for emergency quick reference only. It does not replace the detailed safety information and procedures in the First Responder's Guide (FRG).

ALTERNATE PROCEDURE 2.

1. Open Trunk and Remove Negative Battery Cable.



2. Remove Service Plug.

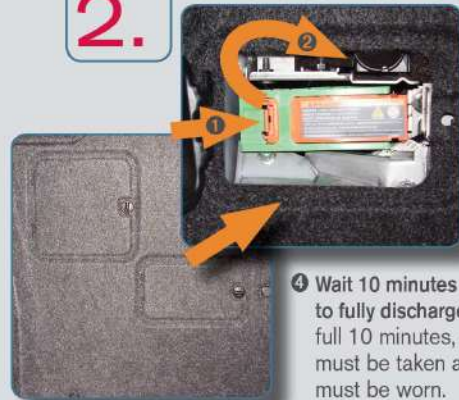

Located behind access cover.

- 1 Release lever locking tab
- 2 Rotate green lever outward.
- 3 Pull to remove.

- 4 Wait 10 minutes for the HV system to fully discharge. If unable to wait full 10 minutes, absolute care must be taken and full PPE must be worn.

HIGH VOLTAGE SYSTEM SHUT DOWN AND VEHICLE DAMAGE LEVEL CONSIDERATIONS

Note: If any air bags have deployed in the following 3 situations, the high-voltage (HV) system has been automatically shut off at the time of deployment.

1) High-voltage (HV) system intact, occupants can be accessed without extrication tools

The HV system can be shut down by following the procedure in this QRG, while wearing appropriate PPE. After HV system shut down, occupant assistance operations can begin immediately, and no wait period is necessary.

(2) High-voltage (HV) system intact, occupants cannot be accessed without extrication tools

The HV system can be shut down by following the procedure in this QRG, while wearing appropriate PPE. After HV system shut down, absolute care must be taken not to cut through or damage any HV system wiring, battery or components within 10 minutes of HV system shut down, but occupant assistance operations using extrication equipment can begin immediately. The locations of the HV component parts are illustrated in this QRG.

(3) High-voltage (HV) system damaged

If there is any evidence that the HV system has been compromised (such as arcing/sparking, orange wiring harnesses cut or damaged, HV component casings damaged, etc.), the responder may still be at risk of high voltage exposure. The vehicle must be approached with extreme caution prior to initiating any system shut down procedures or rendering assistance to occupants. Appropriate PPE must always be worn as described in the FRG, and the 10 minute wait time must be observed after HV system shut down in order to ensure the system is de-energized.

In rare situations where vehicle damage is very severe, HV system shut down procedures as described in the FRG or this QRG may not work. In these instances extreme caution and appropriate risk management must be followed to prevent shock or electrocution to the responder or occupant.

2013 INFINITI M35h

Emergency Responder's Quick Reference Guide

The following is for emergency quick reference only. It does not replace the detailed safety information and procedures in the First Responder's Guide (FRG).

VEHICLE IDENTIFICATION

SRS AIR BAG SYSTEM PARTS LOCATIONS

 = Inflators (Peel back plastic trim parts prior to cutting operations to confirm exact inflator location.)

 = Sensors

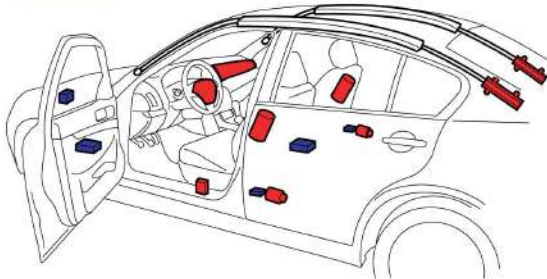

DO NOT Cut Air Bag Parts!

VEHICLE FIRE

- Use standard firefighting equipment.
- Use large amounts of water.
- Be sure Li-ion battery is completely extinguished and cooled to avoid reignition.

VEHICLE SUBMERSION

- Wear appropriate PPE before entering water.
- Vehicle must be removed from water and drained before touching any HV parts.

LI-ION BATTERY ELECTROLYTE CHARACTERISTICS

- Clear in color.
- Sweet odor.
- Similar viscosity to water.
- Highly flammable.
- Skin and eye irritant – rinse with plenty of water and see a doctor immediately.
- Wear appropriate PPE around electrolyte leakage.

HIGH STRENGTH STEEL LOCATIONS

 = High strength steel

 =  DANGER

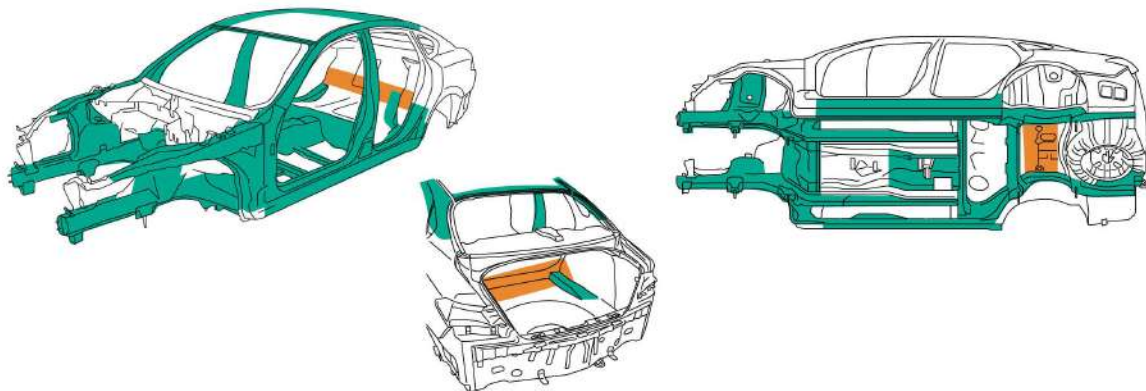

Q4



I N F I N I T I .[®]

© 2012 NISSAN NORTH AMERICA, INC.

All rights reserved.

This document may not be altered without the written permission of NISSAN NORTH AMERICA, INC.

Pub. No. FR3E-1Y51U1