

HONDA

Emergency Response Guide

Honda Gasoline-Electric Hybrid Vehicle

**CIVIC
HYBRID**



Prepared for Fire Service, Law Enforcement, Emergency Medical, and Professional Towing Personnel by American Honda Motor Co., Inc.

Contents

| | |
|---|-----------|
| Key Components | 1 |
| Vehicle Description | |
| Type, Size, Shape, and Materials | 2 |
| Curb Weight | 2 |
| Engine | 2 |
| Electric Motor | 2 |
| 12-Volt Battery | 2 |
| High-Voltage Battery Module | 3 |
| High-Voltage Cables | 4 |
| Airbags and Seat Belts | 4 |
| Hazards | |
| Flammable Fluids | 5 |
| Electric Shock Potential | 5 |
| Battery Electrolyte | 6 |
| Emergency Procedures | |
| Incidents Involving Fire | 7 |
| Submerged or Partially Submerged Vehicle | 7 |
| Preventing Current Flow Through the High-Voltage Cables | 7 |
| How to Remove the Main Fuse and Disconnect the 12-Volt Battery | 10 |
| How to Turn Off the Battery Module Switch | 11 |
| Extricating Occupants | 12 |
| Towing | 13 |

Key Components

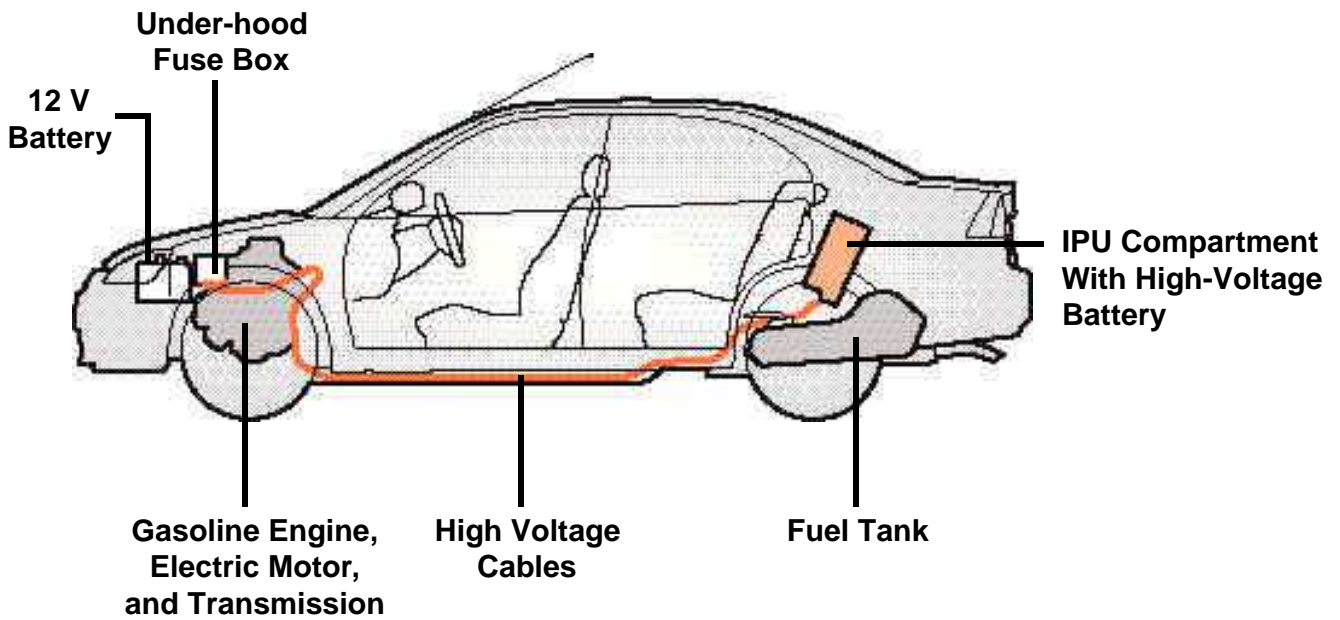
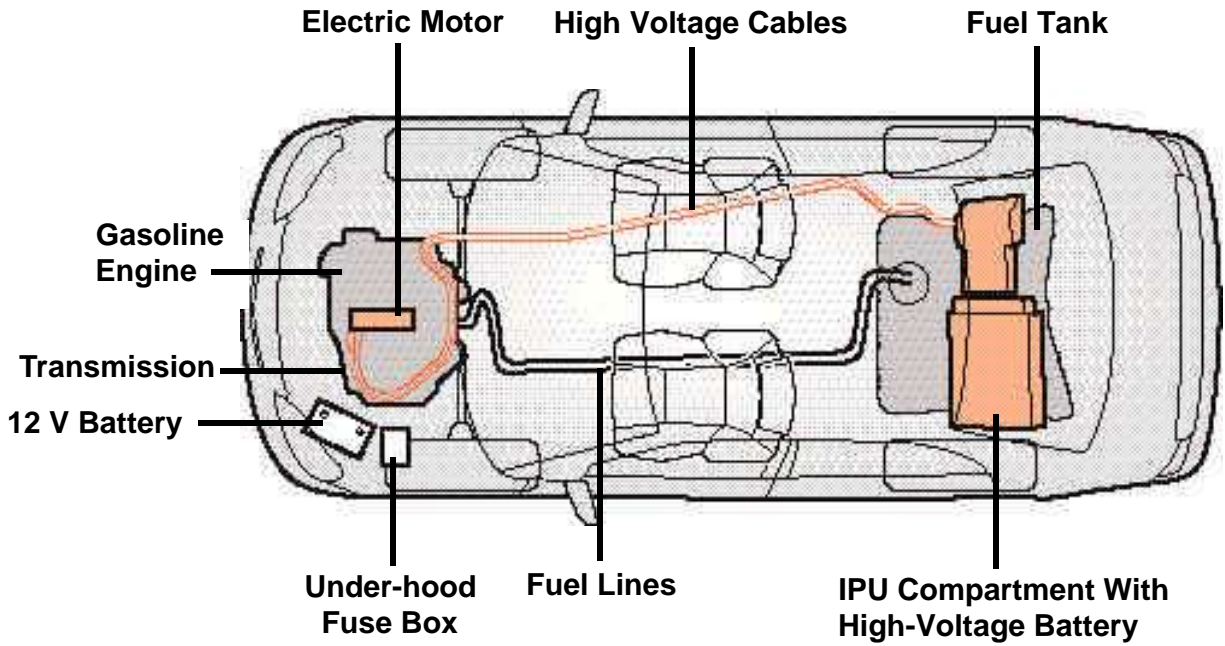

Vehicle Description



HYBRID
GASOLINE ELECTRIC

Type, Size, Shape, and Materials

The Civic Hybrid is a 5-passenger gasoline-electric hybrid vehicle powered by a gasoline engine and an electric motor. The Civic Hybrid resembles a Civic 4-door sedan, except that it has a roof antenna above the windshield. It also has the words, "Hybrid" and "Gasoline-Electric," on the back. Most chassis and body components are made of standard materials like steel, aluminum, and plastic. A few parts are made of magnesium.

Curb Weight

The curb weight of the Civic Hybrid is 2,732 pounds (1,239 kg) for CVT vehicles, and 2,661 pounds (1,207 kg) for manual transmission vehicles.



Gasoline
Engine

Electric
Motor

12 V Battery

Engine

The main power source is a 1.3 liter, 4-cylinder gasoline engine located under the hood.

Electric Motor

During start-up and acceleration, the engine is assisted by a battery-powered electric motor, located between the engine and the transmission. During braking and deceleration, the electric motor acts as a generator to recharge the high-voltage battery and the 12-volt battery. Turning the ignition switch to either the Accessory (I) or the Lock (0) position turns off the engine and the electric motor.

12-Volt Battery

The conventional 12-volt battery under the hood powers all standard electronics such as the lights, audio system, temperature control system, and the engine ignition and fuel injection system.

Vehicle Description, Continued



High-Voltage Battery Module

A nickel-metal-hydride (NiMH) battery module powers the electric motor. The battery module has 120 individual 1.2-volt cells, each about the size of a D cell battery. The battery module is recharged by the electric motor; it never needs external charging.

The battery module has these specifications:

| | |
|------------------|------------------|
| Weight: | 64 lbs (29kg) |
| Nominal Voltage: | 144 volts |
| Capacity: | 6.0 ampere-hours |



IPU Compartment
With Seat-back and Lid Removed

The battery module is inside the Intelligent Power Unit (IPU) compartment. The IPU compartment, shown at the left with the lid removed, is located behind the rear passenger's seat-back. The IPU compartment also contains various controls, electrical components, and cooling fans. All high-voltage components are completely insulated and isolated from the vehicle body.

Vehicle Description, Continued

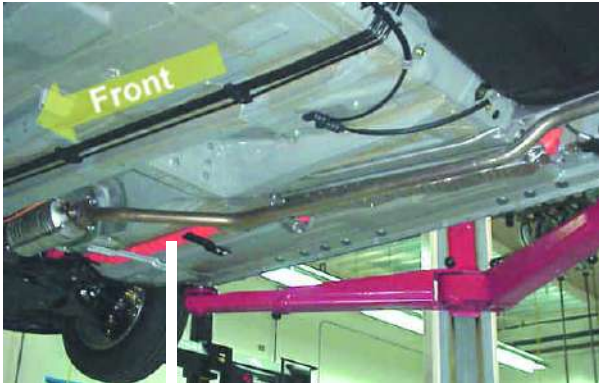

Orange Plastic Shield Undercarriage

High-Voltage Cables

Electrical energy is conducted between the battery module and the electric motor through three heavy-duty, electrically shielded orange cables. The cables are routed on the right side of the vehicle under the front passenger and right rear passenger seats. The cables and shield are bolted to the under-carriage.

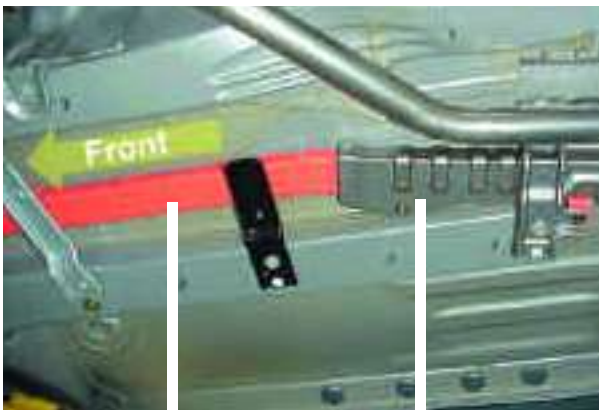

Orange Plastic Shield Thermal Shield

The cables are protected by a sturdy, orange plastic shield, as shown on the left. Near the exhaust pipe, the cables and the plastic shield are protected by a thermal shield.

Airbags and Seat Belts

The Civic Hybrid has dual-stage airbags, side airbags, and pyrotechnic seat belt tensioners in the driver and front passenger positions. All five seating positions have three-point seat belts. To disable (remove power from) the airbags and tensioners, the 12-volt battery must be disconnected for at least 3 minutes.

Hazards

The Civic Hybrid does not present any unusual hazards. It performed well in standard crash tests, with no damage to the high-voltage components in front, side, or rear impacts.

Flammable Fluids

The Civic Hybrid has the same potential fire and explosion hazards as conventional gasoline-powered vehicles. Fluid capacities are:

| | |
|------------------------------|--------------------------|
| Gasoline: | 13.2 gallons (50 liters) |
| Engine Oil: | 3.2 quarts (3.0 liters) |
| Transmission Fluid (CVT): | 3.4 quarts (3.2 liters) |
| (5-speed manual): | 1.6 quarts (1.5 liters) |



High Voltage Alert Symbol

Electric Shock Potential

Unprotected contact with any electrically charged or "hot" high-voltage component can cause serious injury or death. However, receiving an electric shock is highly unlikely because of these facts:

- Contact with the high-voltage battery or other components inside the IPU compartment can occur only if the box is damaged and the contents are exposed, or the box is opened without following proper precautions.
- Contact with the electric motor can occur only after one or more components are removed.
- The high-voltage cables are clearly identified and protected by a strong, plastic shield.

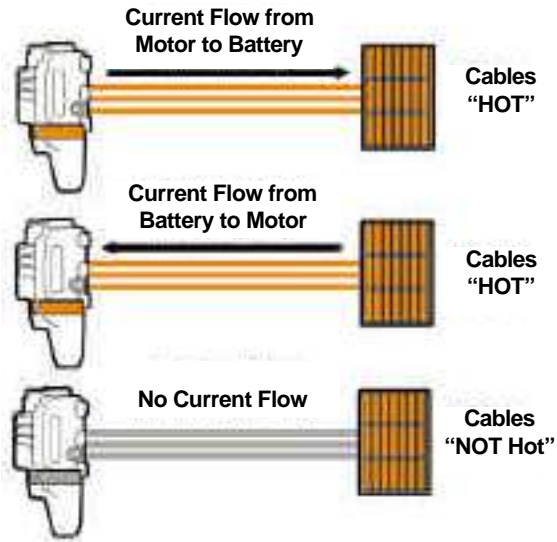

In addition, the cables are potentially "hot" only when:

- The engine is running, and the electric motor is charging the high-voltage battery module.
- The high-voltage battery module is powering the electric motor.

High voltage cannot flow into the cables if the electric motor is not turning and the high-voltage battery module is not sending current to the motor.

Battery Electrolyte

Small quantities of a highly alkaline liquid electrolyte, which is corrosive to human tissue, are used in the manufacture of the high-voltage battery cells. In the finished cells, electrolyte is non-liquid and sealed in a metal case; it cannot spill or leak. The electrolyte is non-flammable, non-explosive, and creates no hazardous fumes or vapors in normal operating conditions or in a fire.

Emergency Procedures

Based on discussions with rescue professionals, we recommend that emergency response personnel follow standard procedures developed by their own organization for assessing situations and dealing with potential hazards. Given our knowledge of the Civic Hybrid, we also recommend you use the procedures outlined in this section.

Incidents Involving Fire

If the vehicle or its IPU compartment becomes involved in a fire, there are no unusual hazards; follow standard fire-fighting procedures.

Submerged or Partially Submerged Vehicle

Pull the vehicle out of the water, then use one of the procedures under Preventing Current Flow Through the High-Voltage Cables to reduce the possibility of current flow. There is no danger of electric shock from touching the car body or framework.

Preventing Current Flow Through the High-Voltage Cables

Before attempting to rescue occupants or moving a damaged vehicle, you should reduce the potential for current to flow from the electric motor or battery module through the high-voltage cables. Here are three ways to do this, from the best method to the least desirable.

Emergency Procedures, Continued



Ignition Switch

Ignition Key

Best Method for Preventing Current Flow

Turn the ignition switch off.

This simple action turns off the engine and the electric motor, preventing current flow into the cables.

Turning the ignition switch off also turns off power to the airbags and the seat belt tensioners.

After you turn the ignition switch off, remove the key so the car cannot be accidentally restarted.

Second Best Method for Preventing Current Flow

Remove the main fuse, and disconnect the negative cable from the 12-volt battery.

NOTE: For instructions on this method, see page 10.

Removing the main fuse turns off the engine and the electric motor, preventing current flow from the motor into the cables. Removing the fuse also cuts power to the airbags and the seat belt tensioners.

Disconnecting the negative cable from the 12-volt battery disables the high-voltage battery controller, preventing current flow from the controller into the cables.

Emergency Procedures, Continued

Least Desirable Method for Preventing Current Flow:

Turn off the battery module switch on the IPU compartment.

NOTE: For instructions on this method, see page 11.

Turning off the battery module switch prevents current flow from the battery module into the cables.

This method of preventing current flow is least desirable because of these facts:

- If the engine is running, you could be dealing with "hot" high-voltage cables.
- This method does not cut power to the airbags or seat belt tensioners, so extra caution must be used.

If you cannot do any of the three methods to prevent current flow into the high-voltage cables, use extreme care, do not cut into the cables, and do not touch them as they may potentially be "hot."

Emergency Procedures, Continued



12 V Battery Under-hood Fuse Box



Under-hood Fuse Box Cover Main Fuse



Positive Cable Negative Cable

How to Remove the Main Fuse and Disconnect the 12-Volt Battery

NOTE: Do this only if you cannot turn the ignition switch off.

1. Remove the under-hood fuse box cover. The under-hood fuse box is in the engine compartment, on the driver's side.
2. Unscrew the main fuse (#1) with a Phillips screwdriver, and remove it from the fuse box.
3. Using a 10 mm wrench or pliers, loosen and remove the negative terminal from the 12-volt battery. You can also disconnect the battery negative cable by cutting it near the top of the battery with diagonal cutters.

Emergency Procedures, Continued



IPU Box Lid

Rear Seat-Back

How to Turn Off the Battery Module Switch

NOTE: Do this only if you cannot turn the ignition switch off or reach the under-hood fuse box.

1. Remove the rear seat (seat cushion and seat-back). Use a 10 mm wrench, a crescent wrench, or pliers to remove the bolt from the top center of the seat cushion and the bolt at each lower corner of the seat-back. After you remove the bolts, pull up the seat cushion and the seat-back to remove them. This gives you access to the lid of the IPU compartment.



Battery Module Switch Cover

Bolts

2. Using a 10 mm wrench, a crescent wrench, or pliers, unscrew the two bolts from the battery module switch cover, then remove the cover.

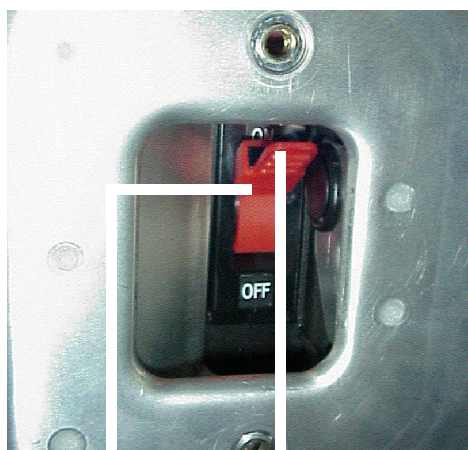

Locking Cover

Battery Module Switch

3. Remove the red locking cover from the switch, then flip the switch from ON to OFF.

4. Reattach the red locking cover to the switch. This prevents you from accidentally flipping the switch to ON.

Emergency Procedures, Continued

Extricating Occupants

If "Jaws of Life"-type equipment is required to remove the occupants from a damaged vehicle, make sure you stay within the cut zones shown below.

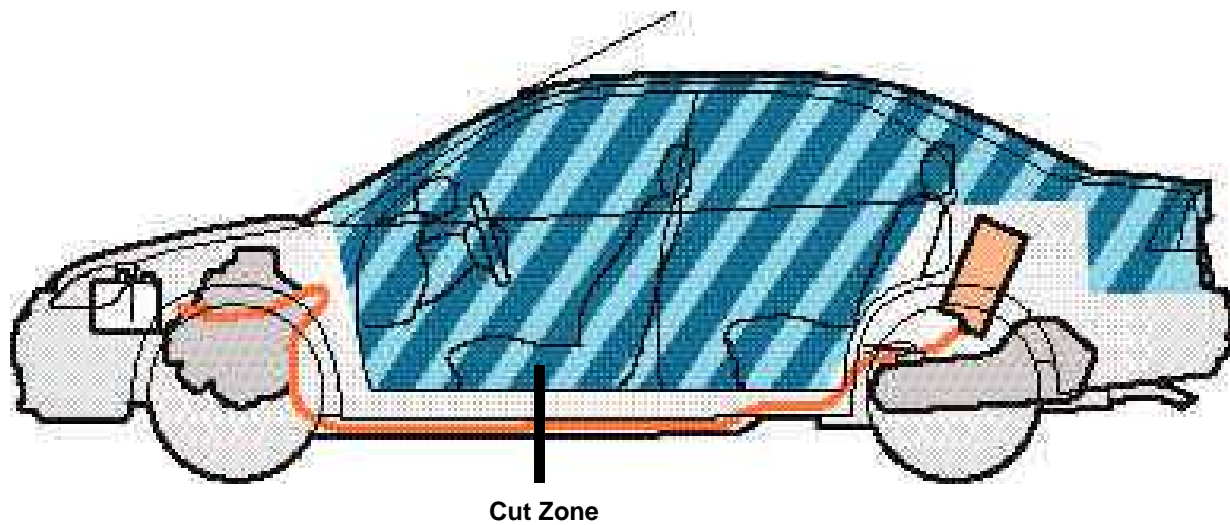

Towing

If you need to move the car only a short distance, such as to the side of the road, and the car can still roll on the ground, the easiest way is to shift to neutral and push it manually.

The preferred method for towing a Civic Hybrid away from an emergency location is on a flat-bed truck. If a flat-bed is not available, wheel-lift equipment may be used, preferably with the front wheels lifted. If the rear wheels must be raised, be sure to first set the parking brake and shift the transmission to neutral.

Do not use sling-type towing equipment unless the car has been damaged beyond repair.

Copyright © 2002, American Honda Motor Co., Inc.
Reorder Number Y0644
AXX 23817 (0206)