



Emergency Response Guide



2013 ILX Hybrid



Prepared for Fire Service, Law Enforcement, Emergency Medical, and Professional Towing Personnel by American Honda Motor Co., Inc.

Introduction

This information has been prepared to help emergency response professionals identify an Acura ILX gasoline-electric hybrid and safely respond to incidents involving this vehicle.

We hope this publication provides the kind of information you need. As with other Honda Emergency Response Guides, it is available for reference or downloading at <https://techinfo.honda.com>

If you have any questions or wish to order printed copies please contact your local Acura dealer or Acura Client Relations at (800) 382-2238.

Acura wants to thank you for your concern and efforts in protecting Acura customers and the general public.

Contents

- **Introduction**
- **Vehicle Description**
 - Identifying an Acura ILX Hybrid
 - Key Components
 - Gasoline Engine
 - Electric Motor
 - 12-Volt Battery
 - Underhood Fuse Box
 - High-Voltage Battery Module
 - High-Voltage Battery Box
 - High-Voltage Cables
- **Potential Hazards**
 - Flammable Fluids
 - Undeployed Airbags and Tensioners
 - Electric Shock Potential
 - High-Voltage Battery Electrolyte
 - 12-Volt Battery Electrolyte
- **Emergency Procedures**
 - Vehicle Fire
 - Submerged or Partially Submerged Vehicle
 - Preventing Current Flow Through High-Voltage Cables
 - Best Method for Preventing High-Voltage Current Flow
 - Second-Best Method for Preventing High-Voltage Current Flow
 - Extricating Occupants
 - Cut Zone
 - Moving or Towing a Acura ILX Hybrid

Vehicle Description

IDENTIFYING AN ACURA ILX HYBRID



The easiest way to identify an Acura ILX Hybrid is by the word "Hybrid" on the trunk and two front fenders.



Vehicle Description

IDENTIFYING AN ACURA ILX HYBRID

If the word “Hybrid” is not visible on the exterior, the presence of orange cables under the hood, or orange conduit on the underside of the vehicle also identify it as a hybrid.



Orange cables under the hood, or orange shielding fastened to the underside of the vehicle also tell you it is a hybrid.

Vehicle Description

KEY COMPONENTS

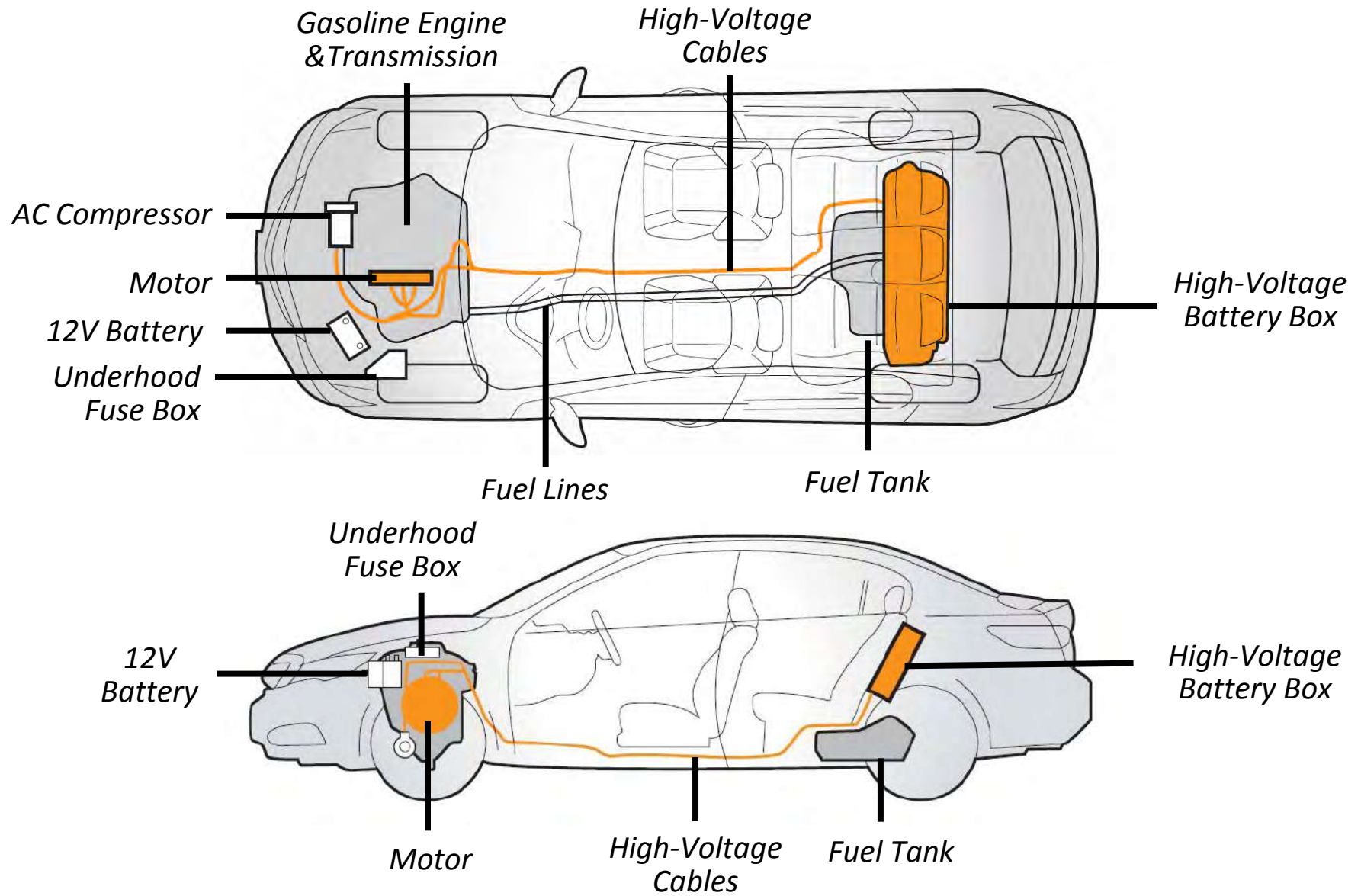

Vehicle Description

GASOLINE ENGINE

The main power source of an Acura ILX Hybrid is a conventional gasoline engine, located under the hood.



ELECTRIC MOTOR

During start-up and acceleration, an electric motor, located between the engine and the transmission, provides assistance to the engine. During braking and deceleration, the motor acts as a generator, recharging both the high-voltage battery module and the 12-volt battery.

Vehicle Description

12-VOLT BATTERY

A conventional 12-volt battery located under the hood powers all standard electronics. It also provides power to the high-voltage battery control systems. Disconnecting or cutting the negative cable to the 12-volt battery may be necessary in an emergency situation.

UNDERHOOD FUSE BOX

The Acura ILX Hybrid has a fuse box under the hood on the left side of the engine compartment. Removing the main fuse from the fuse box may be required in an emergency situation.



*Underhood
Fuse Box*

*12-Volt
Battery*

Vehicle Description

HIGH-VOLTAGE BATTERY MODULE

The electric motor in the Acura ILX Hybrid is powered by a lithium ion (Li-Ion) battery module. This battery module contains four groups, or “stacks,” of ten 3.6-volt cells. Each cell is slightly larger than some cellular phones. The total voltage is 144 volts.

Since the battery module is recharged by the electric motor whenever the vehicle decelerates, the battery does not need external charging.



*One of Four
Battery
“Stacks”*

Vehicle Description

HIGH-VOLTAGE BATTERY BOX

The high-voltage battery module is surrounded by a sturdy metal framework, such as that shown here with the cover removed. The battery is packaged with other important components which, together, make up the Intelligent Power Unit (IPU). All high-voltage circuits inside the IPU are completely insulated and isolated from the vehicle body.

For maximum safety, the high-voltage battery box is positioned behind the seat-backs where it is well-protected from potential damage in a collision.

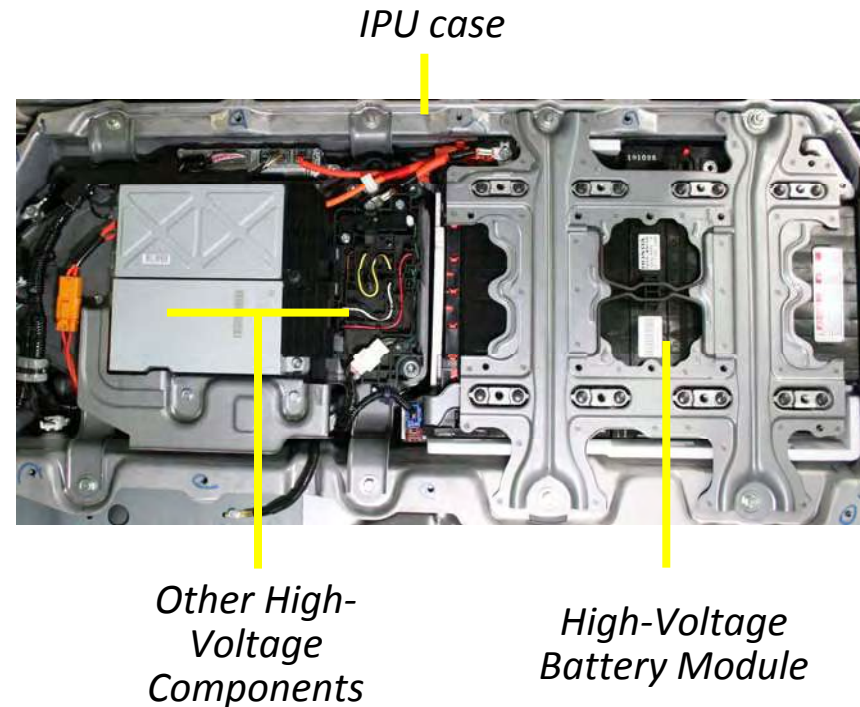

Vehicle Description

HIGH-VOLTAGE CABLES

Electrical energy flows between the IPU and the motor through heavy-duty orange cables.

In addition, high-voltage cables also deliver current to an electric motor that turns the air conditioning (AC) compressor. This allows the AC to continue running when the gasoline engine is turned off during auto idle stop mode. (Under certain conditions, auto idle stop automatically turns the gasoline engine off when the car comes to a stop, at a stop light for example.)

Between the IPU and the engine compartment, the high-voltage cables are routed under the vehicle inside sturdy orange conduit.



High-Voltage Cable Connection to Motor

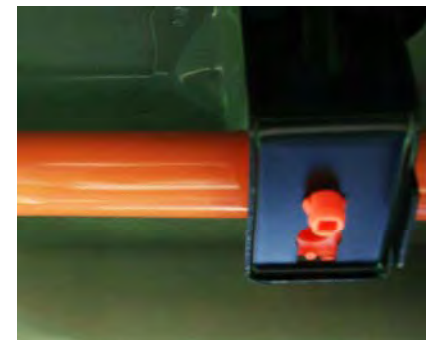

Orange pipe protective shields to undercarriage

Potential Hazards

Except in the most severe of collisions that might breach the IPU or expose the high voltage wires, the Acura ILX Hybrid does not present any unusual hazards. The vehicles has performed well in government required crash testing, with no damage to high-voltage components.

FLAMMABLE FLUIDS

As with a conventional automobile, the Acura ILX Hybrid carries flammable fluids that present potential fire and explosion hazards. The maximum quantities are provided below:



Gasoline:	13.2 gallons (50 liters)
Engine Oil:	3.8 quarts (3.6 liters)
Transmission Fluid:	3.0 quarts (2.8 liters)

Potential Hazards

UNDEPLOYED AIRBAGS AND TENSIONERS

The Acura ILX Hybrid is equipped with the following pyrotechnic devices:

Front Airbags:	Driver & front passenger
Side Airbags:	Driver & front passenger
Tensioners:	Driver & front passenger
Side Curtain Airbags:	Driver, front passenger & outer rear passengers

Their deactivation time is 3 minutes.



Follow recommended procedures to avoid possible injury from a deploying airbag inflator or seatbelt tensioner.

As with other airbag-equipped vehicles, being struck by a deploying front or side airbag, or cutting into an unactivated inflator, can result in moderate to severe injuries. Injuries can also result from contact with a deploying side curtain airbag, or having a seat belt tensioner activate unexpectedly.

Potential Hazards

ELECTRIC SHOCK POTENTIAL

Unprotected contact with any electrically charged (“hot” or “live”) high-voltage component can cause serious injury or death. However, receiving an electric shock from an Acura ILX Hybrid is highly unlikely because of the following:

- Contact with the battery module or other components inside the IPU only can occur if it is damaged and the contents are exposed or if it is opened without following proper precautions.
- Contact with the electric motor only can occur after one or more components are removed.
- The high-voltage cables can be easily identified by their distinctive orange color, and contact with them can be avoided.

Potential Hazards

It's also important to understand in what situations the high-voltage cables potentially can be "hot":

Whenever the ignition switch is in the ON position and the engine is running, the high-voltage battery either is supplying current to the electric motor or receiving current generated by the electric motor.

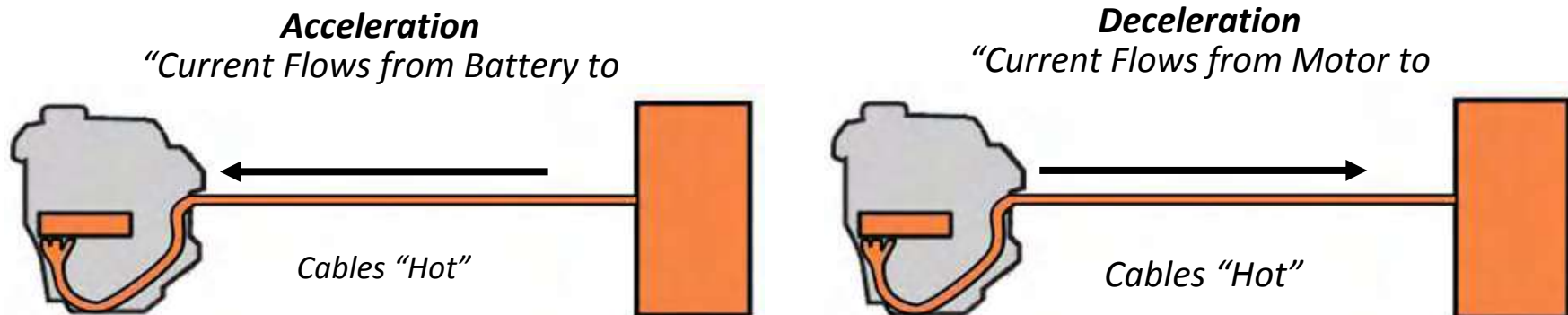

Potential Hazards

The high-voltage battery also powers the air conditioner compressor. So, if the ignition is in the ON position, the air conditioner is on, and the gasoline engine has been turned off by the auto idle stop feature (at a stop light, for example), current will flow through the cables to the air conditioning (AC) compressor.

Ignition ON, gasoline engine stopped
Current Flows from Battery to AC Compressor

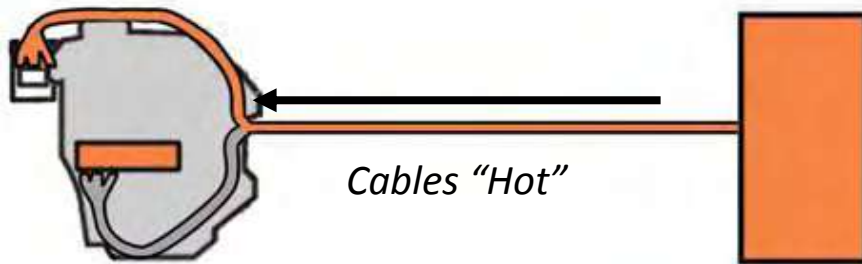

Ignition Switch is OFF

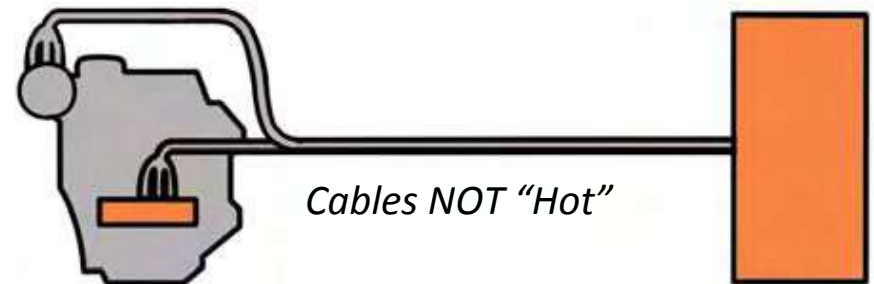

If the ignition is turned off, the flow of high-voltage current will stop.

The lesson, therefore, is: ***Electric current doesn't flow into the high-voltage cables when the ignition is OFF.***

Potential Hazards

HIGH-VOLTAGE BATTERY ELECTROLYTE

The electrolyte in the Li-Ion battery module in the Acura ILX Hybrid is flammable. If the battery cell is broken open and the electrolyte is ignited, it will give off gases that can cause irritation if inhaled. Without ignition, a small amount of electrolyte may simply leak out, and appropriate skin and eye protection are recommended.

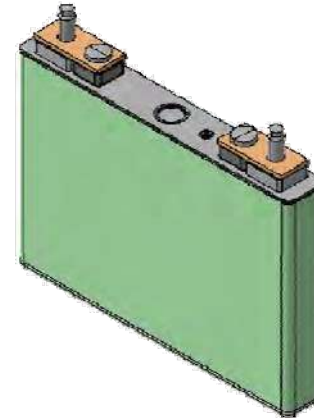

Electrolyte in the high-voltage Li-Ion battery cells is flammable.

12-VOLT BATTERY ELECTROLYTE

Any hazards from contact with the 12-volt battery electrolyte are the same as those with 12-volt batteries in conventional passenger vehicles.

Emergency Procedures

Based on discussions with rescue professionals, we recommend that emergency response personnel follow standard procedures developed by their own organizations for assessing situations and dealing with potential hazards. Given our knowledge of the Acura ILX Hybrid, we also recommend that you use the recommendations outlined in this section.

VEHICLE FIRE

If approaching an Acura ILX Hybrid that is on fire, use standard vehicle fire fighting techniques and equipment. If the high-voltage battery is on fire, the battery manufacturer recommends using either large amounts of water or a CO2 fire extinguisher.

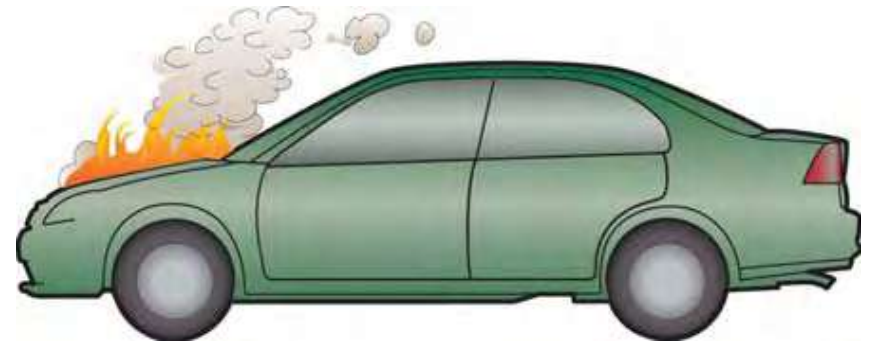

Emergency Procedures

SUBMERGED OR PARTIALLY SUBMERGED VEHICLE

Pull the vehicle out of the water, then use one of the following procedures for preventing electric current from flowing through the high-voltage cables.

There is no risk of electric shock from touching the car's body or framework - in or out of the water.

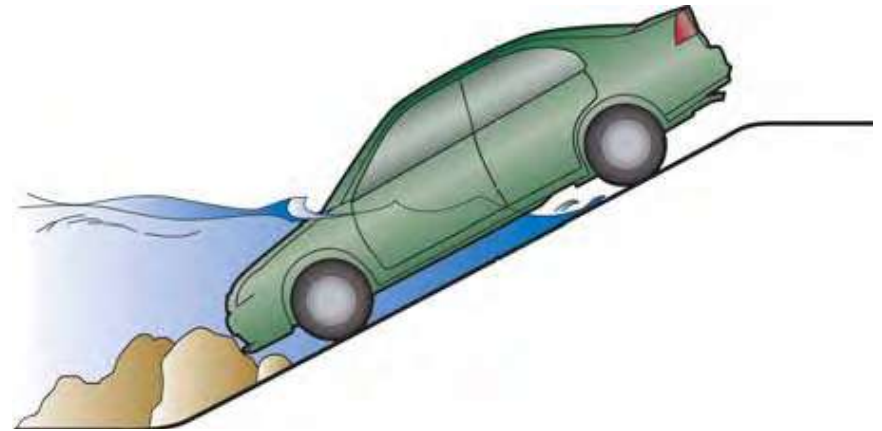

Pull vehicle from water, then follow recommended procedures for preventing high-voltage current flow.

Emergency Procedures

PREVENTING CURRENT FLOW THROUGH HIGH-VOLTAGE CABLES

Before attempting to rescue occupants or move a damaged Acura ILX Hybrid, you should reduce the potential for current to flow from the electric motor or the battery module through the high-voltage cables.

There are *two recommended methods* for preventing current flow. These are discussed on the following pages.

Emergency Procedures

BEST METHOD FOR PREVENTING HIGH-VOLTAGE CURRENT FLOW

Push and hold the Start/Stop button for 3 seconds

This simple action turns off the gasoline engine and immediately shuts down the high-voltage system controllers, thereby preventing current flow into the cables. It also cuts power to the airbags and the seat belt tensioners, though these pyrotechnic devices have a three minute deactivation time.



Push and hold the start/stop button for 3 seconds

To prevent accidental restarting, you must remove the keyless remote from the vehicle and move it at least 20 feet away.

If you cannot locate the keyless remote, you should also perform the **SECOND-BEST METHOD** (for preventing high-voltage current flow) on the following page.

Emergency Procedures

SECOND-BEST METHOD FOR PREVENTING HIGH-VOLTAGE CURRENT FLOW

***Cut both negative 12-volt battery cables
and remove the 12-volt main fuse.***

Together, cutting the negative 12-volt battery cables and removing the 12-volt main fuse turns off the gasoline engine and immediately shuts down the high-voltage system controllers, thereby preventing current flow into the cables. It also cuts power to the airbags and the seat belt tensioners, though these pyrotechnic devices have a three minute deactivation time.

1. Locate the 12-volt battery and cut the negative cables.

Continued on next page

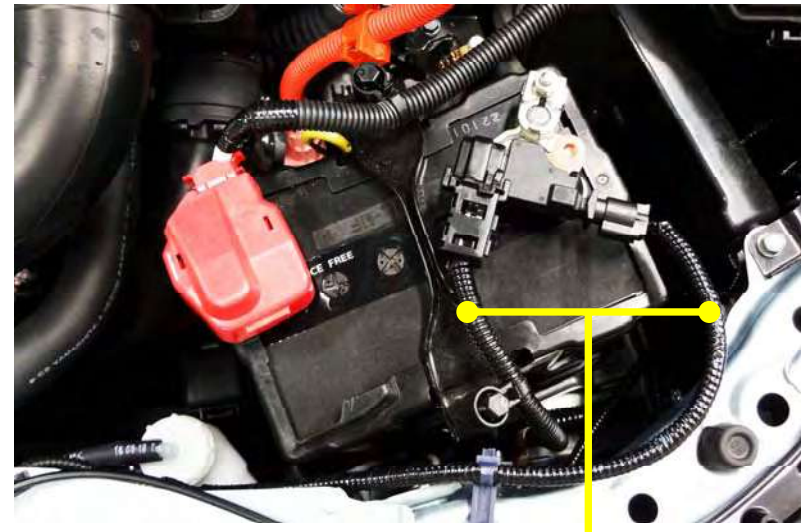

Negative Cables

Emergency Procedures

2. Locate the underhood fuse box, and remove the cover.
3. Locate the main fuse by referring to the diagram inside the fuse box cover.
4. Using a Phillips screwdriver, remove the main fuse screw and then remove the main fuse.

NOTE: If you cannot perform either method to stop the engine and prevent current flow into the high-voltage cables, use extreme care, do not cut into the cables, and do not touch damaged cables as they may be “hot.”



Underhood Fuse Box

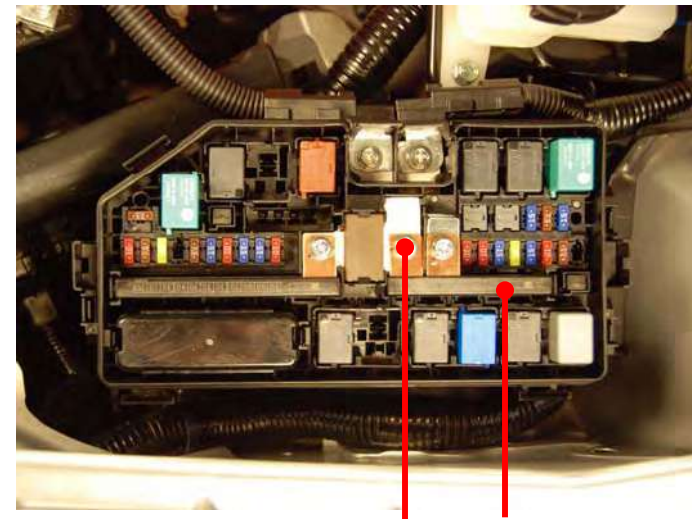

Main Fuse Screw / Main Fuse

Emergency Procedures

EXTRICATING OCCUPANTS

If cutters or spreaders are needed to allow occupants to be rescued, make sure to stay within the cut zone identified in light blue below.

CUT ZONE

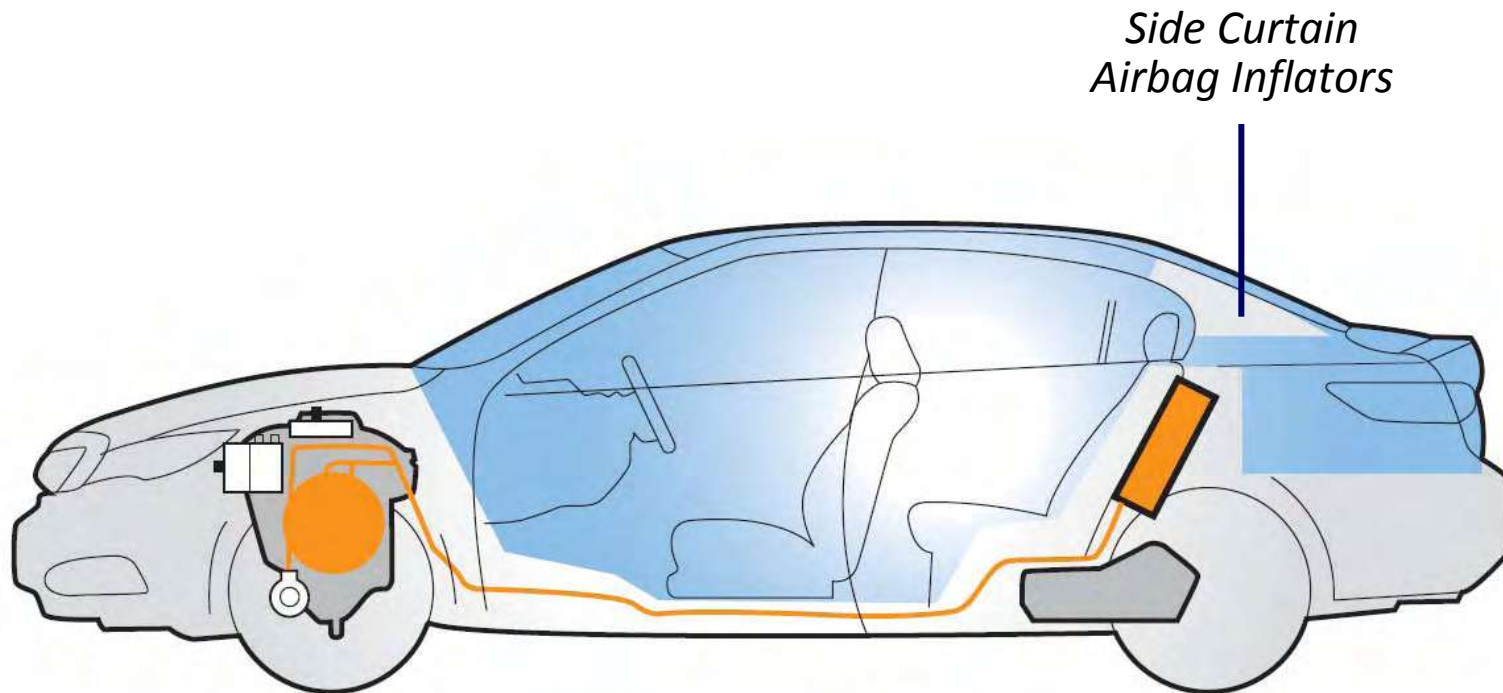

Vehicle Description

MOVING AND TOWING AN ACURA ILX HYBRID

If a disabled Acura ILX Hybrid needs to be moved a short distance (to the side of the road, for example), and the car can still roll on the ground, the easiest way is to shift the transmission into neutral and manually push the vehicle.

To transport a vehicle away from an emergency location, a flatbed truck should be used if the vehicle might be repaired. If a flatbed is not available, the vehicle should be towed by wheel-lift equipment with the front wheels off the ground. Do not use sling-type towing equipment unless the car has been damaged beyond repair.

Copyright 2012, American Honda Motor Co., Inc.

E2530